

# M Series Mechanical Valve(3/2,5/2 Way)



# M

## Mechanical Valve (3/2,5/2)



Three way two position

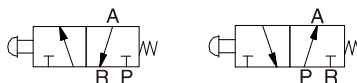

Five way two position

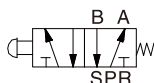

### How to Order?

Series No.	Ways	Positions	Port Size	Button Type	Thread Type
MV	3: 3 ways	2: 2 position	06: 1/8"	Blank: No button	Blank: G
MJ	5: 5 ways		08: 1/4"	S1B: The button with arrow mark(Black)	P: PT
M				S2: Roller type	T: NPT
				S3R: Button with "Reset" mark(Red)	
				S4G: Concave button(Green)	
				S5R: Flat button(Red)	
				S6R: Mushroom head button(Red)	
				S6B: Mushroom head button(Black)	
				Note: S1 and S3 with manual return, Others with spring return.	

#### Order Example:

M series mechanical valve, 3/2 way, 1/8" port size, with black button with arrow mark, G thread, ERP code is: M32-06S1B

Note: Button mechanical valve assembly comprising: a Button component, the mounting bracket, under mounting brackets and mounting screws.

### Specifications

Model	MV32-06	MJ32-08	M32-08	M52-08
Working medium	Clean air(After $\mu\text{m}$ filtration)			
Acting type	External control			
Lubrication	Not required			
Working pressure (MPa)	0~0.8			
Guaranteed pressure (MPa)	1.2			
Working temperature ( $^{\circ}\text{C}$ )	-5~60			
Max. acting frequency	5 cycles/s			
Port size	1/8 , 1/4			

### Product Features

- \* Black color is standard color, different colors are optional
- \* Controlled by mechanical force
- \* Various buttons are available

### Main Dimension for Button

S1

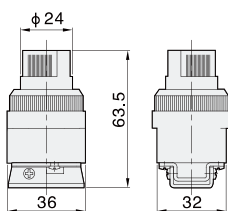

S2

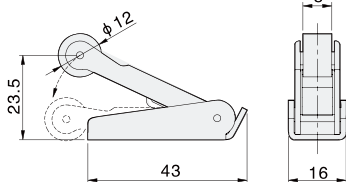

S3

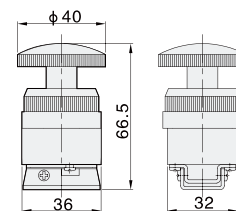

## ◎ Main Dimension for Button

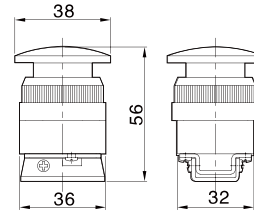
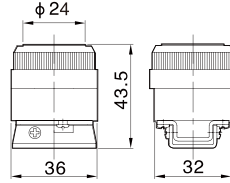
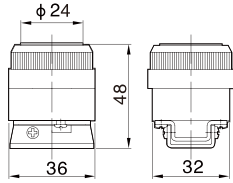

## ◎ Main Dimension

### MV32 Series



MV32-06S1



MV32-06S2



MV32-06S3



MV32-06S4



MV32-06S5



MV32-06S6

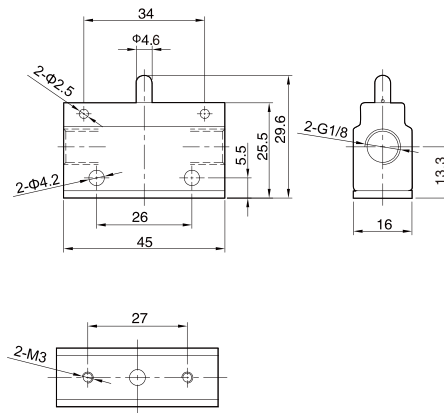

### MJ32 Series



MJ32-08S1



MJ32-08S2



MJ32-08S3



MJ32-08S4



MJ32-08S5



MJ32-08S6

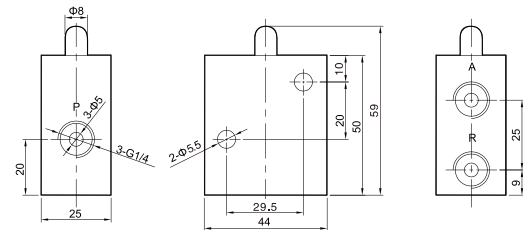

# M Series Mechanical Valve(3/2,5/2 Way)



## ○ Main Dimension

### M32 Series

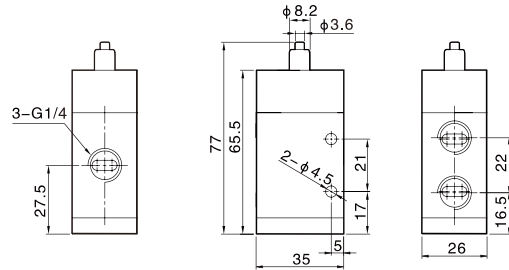

### M52 Series

