

ZS Series 2/2 Solenoid Valve(Normal Close)

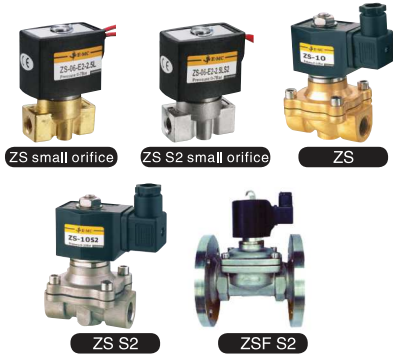

ZS

2/2 Solenoid Valve (N.C.)

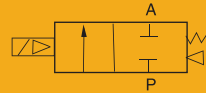

Product Features

- * Normal close/Normal open, available body: brass, SS304, SS316
- * Multiple seals are available for different medium
- * To reduce the power consumption of 80% energy-saving
- * Wide size range from 1/8" to 2", with both thread and flange connection
- * Diaphragm pilot solenoid valve, with lower working pressure (10mm is special)

How to Order?

Series No.	Port size	Original status	Orifice	ID Code	Voltage	Valve body material	Seal material	Thread type
ZS: Thread connection ZSF: Flange connection		Blank: NC H: NO		Blank: Standard type N: Low power type		Blank: Brass S1: SS316 S2: SS304	Blank: NBR E: EPDM V: VITON Si: Silicon (smaller than $\Phi 25\text{mm}$ is optional)	Blank: G P: PT T: NPT
	06: 1/8"		025: 2.5mm	E1: AC110V	E6: AC36V			
	08: 1/4"		025: 2.5mm 100: 10mm	E2: AC220V	E7: AC24V			
	10: 3/8"		040: 4mm 160: 16mm 100: 10mm	E3: AC380V	E8: DC110V			
	15: 1/2"		100: 10mm 160: 16mm	E4: DC24V	E9: DC48V			
	20: 3/4"		200: 20mm	E5: DC12V	E10: DC36V			
	25: 1"		250: 25mm					
	32: 1-1/4"		350: 35mm					
	40: 1-1/2"		400: 40mm					
	50: 2"		500: 50mm					
	Flange connection		250: 25mm 650: 65mm 320: 32mm 800: 80mm 400: 40mm 1000: 100mm 500: 50mm					

(Note: cancel if same with port size)

Order Example:

ZS series solenoid valve, 1/2" port size, NC, 16mm orifice, standard type, AC110V, Brass valve body, NBR seal, G thread, ERP code is: ZS15-160E1
Note: 2.5mm small orifice valve only with flying leads coil, other orifice with DIN connector coil.

Main Dimension

$\Phi 2.5\text{mm}$ 1/8" 1/4"

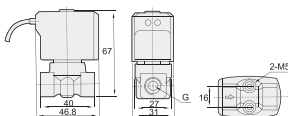

10mm, 1/4", 3/8", 1/2"

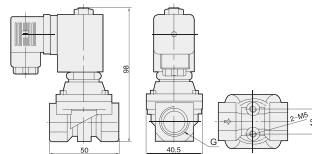

$\Phi 4\text{mm}$ 3/8"

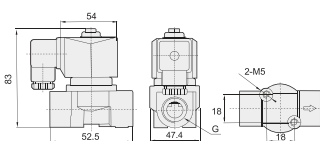

Large diameter

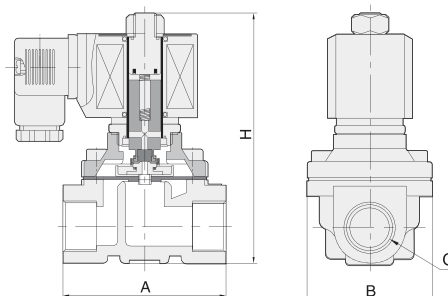

ZS Series 2/2 Solenoid Valve(Normal Close)



Specifications

Port size (G)	Orifice (mm)	CV value	Min. pressure	Pressure difference (Bar)						Max. temperature (°C)	Power		Order code 220VAC		Main dimension Length x Width x Height A x B x H(mm)
				Max. working pressure							AC 220	DC 24V	Brass	Stainless steel 304	
				Air, Gas		Hot water, Liquid		Light oil ≤20CST							
1/8 "	2.5	0.23	0	7	5	7	5	7	5	80	13	8.5	ZS06-025E2	ZS06-025E2S2	46.8 x 31 x 67
	2.5	0.23	0	7	5	7	5	-	-	120	13	8.5	ZS06-025E2E	ZS06-025E2S2E	46.8 x 31 x 67
	2.5	0.23	0	7	5	7	5	7	5	120	13	8.5	ZS06-025E2V	ZS06-025E2S2V	46.8 x 31 x 67
1/4 "	2.5	0.23	0	7	5	7	5	7	5	80	13	8.5	ZS08-025E2	ZS08-025E2S2	46.8 x 31 x 67
	2.5	0.23	0	7	5	7	5	-	-	120	13	8.5	ZS08-025E2E	ZS08-025E2S2E	46.8 x 31 x 67
	2.5	0.23	0	7	5	7	5	7	5	120	13	8.5	ZS08-025E2V	ZS08-025E2S2V	46.8 x 31 x 67
	10	1	0	20	16	20	16	20	16	80	22	13	ZS08-100E2	-	50 x 40.5 x 98
	10	1	0	20	16	20	16	-	-	120	22	13	ZS08-100E2E	-	50 x 40.5 x 98
3/8 "	4	0.6	0	8	5	8	5	5	5	80	33	20	ZS10-040E2	ZS10-040E2S2	52.5 x 47.5 x 83
	4	0.6	0	8	5	8	5	-	-	120	33	20	ZS10-040E2E	ZS10-040E2S2E	52.5 x 47.5 x 83
	4	0.6	0	8	5	8	5	5	5	120	33	20	ZS10-040E2V	ZS10-040E2S2V	52.5 x 47.5 x 83
	10	1.8	0	20	16	20	16	20	16	80	22	13	ZS10E2	-	50 x 40.5 x 98
	10	1.8	0	20	16	20	16	-	-	120	22	13	ZS10E2E	-	50 x 40.5 x 98
	10	1.8	0	20	16	20	16	20	16	120	22	13	ZS10E2V	-	50 x 40.5 x 98
	16	4.8	0	10	6	10	6	7	4	80	33	20	ZS10-160E2	ZS10-160E2S2	69 x 75 x 106
	16	4.8	0	10	6	10	6	-	-	120	33	20	ZS10-160E2E	ZS10-160E2S2E	69 x 75 x 106
1/2 "	10	1.9	0	20	16	20	16	20	16	80	22	13	ZS15-100E2	-	69 x 75 x 106
	10	1.9	0	20	16	20	16	-	-	130	22	13	ZS15-100E2E	-	69 x 75 x 106
	10	1.9	0	20	16	20	16	20	16	120	22	13	ZS15-100E2V	-	69 x 75 x 106
	16	4.8	0	10	6	10	6	7	4	80	33	20	ZS15-160E2	ZS15-160E2S2	69 x 75 x 106
	16	4.8	0	10	6	10	6	-	-	130	33	20	ZS15-160E2E	ZS15-160E2S2E	69 x 75 x 106
3/4 "	20	7.6	0	10	6	10	6	7	4	80	33	20	ZS20E2	ZS20E2S2	73 x 57 x 114
	20	7.6	0	10	6	10	6	-	-	130	33	20	ZS20E2E	ZS20E2S2E	73 x 57 x 114
	20	7.6	0	10	6	10	6	7	4	120	33	20	ZS20E2V	ZS20E2S2V	73 x 57 x 114
1 "	25	12	0	10	6	10	6	7	4	80	33	20	ZS25E2	ZS25E2S2	99 x 77 x 121
	25	12	0	10	6	10	6	-	-	120	33	20	ZS25E2E	ZS25E2S2E	99 x 77 x 121
	25	12	0	10	6	10	6	7	4	120	33	20	ZS25E2V	ZS25E2S2V	99 x 77 x 121
	25	12	0	10	6	3	3	-	-	120	33	20	ZS25E2G	ZS25E2S2G	99 x 77 x 121
1-1/4 "	35	24	0	10	6	10	6	7	4	80	70	40	ZS32-350E2	ZS32-350E2S2	112 x 86.5 x 150
	35	24	0	10	6	10	-	-	-	120	70	40	ZS32-350E2E	ZS32-350E2S2E	112 x 86.5 x 150
	35	24	0	10	6	10	6	7	4	120	70	40	ZS32-350E2V	ZS32-350E2S2V	112 x 86.5 x 150
1-1/2 "	40	29	0	10	6	10	6	7	4	80	70	40	ZS40E2	ZS40E2S2	123 x 94 x 160
	40	29	0	10	6	10	-	-	-	120	70	40	ZS40E2E	ZS40E2S2E	123 x 94 x 160
	40	29	0	10	6	10	6	7	7	120	70	40	ZS40E2V	ZS40E2S2V	123 x 94 x 160
2 "	50	48	0	10	6	10	6	7	4	80	70	40	ZS50E2	ZS50E2S2	168 x 123 x 183
	50	48	0	10	6	10	-	-	-	120	70	40	ZS50E2E	ZS50E2S2E	168 x 123 x 183
	50	48	0	10	6	10	6	7	4	120	70	40	ZS50E2V	ZS50E2S2V	168 x 123 x 183
Flange 4 hole	25	12	0	10	6	10	6	7	4	80	70	40	-	ZSF25E2S2	140 x 115 x 160
	25	12	0	10	6	10	-	-	-	130	70	40	-	ZSF25E2S2E	140 x 115 x 160
	25	12	0	10	6	10	6	7	4	120	70	40	-	ZSF25E2S2V	140 x 115 x 160
	32	24	0	10	6	10	6	7	4	80	70	40	-	ZSF32-350E2S2	152 x 135 x 215
	32	24	0	10	6	10	-	-	-	130	70	40	-	ZSF32-350E2S2E	152 x 135 x 215
	32	24	0	10	6	10	6	7	4	120	70	40	-	ZSF32-350E2S2V	152 x 135 x 215
	40	29	0	10	6	10	6	7	4	80	70	40	-	ZSF40E2S2	152 x 135 x 215
	40	29	0	10	6	10	-	-	-	130	70	40	-	ZSF40E2S2E	152 x 135 x 215
	40	29	0	10	6	10	6	7	4	120	70	40	-	ZSF40E2S2V	152 x 135 x 215
	50	48	0	10	6	10	6	7	4	80	70	40	-	ZSF50E2S2	195 x 160 x 220
	50	48	0	10	6	10	-	-	-	130	70	40	-	ZSF50E2S2E	195 x 160 x 220
	50	48	0	10	6	10	6	7	4	120	70	40	-	ZSF50E2S2V	195 x 160 x 220
	65	75	0	6	5	6	5	3	2	80	55	64	-	ZSF65E2S2	250 x 185 x 308
	65	75	0	6	5	6	5	-	-	120	55	64	-	ZSF65E2S2E	250 x 185 x 308
	65	75	0	6	5	6	5	3	2	120	55	64	-	ZSF65E2S2V	250 x 185 x 308
	80	90	0	6	5	6	5	3	2	80	55	64	-	ZSF80E2S2	270 x 202 x 320
	80	90	0	6	5	6	5	-	-	120	55	64	-	ZSF80E2S2E	270 x 202 x 320
80	90	0	6	5	6	5	3	2	120	55	64	-	ZSF80E2S2V	270 x 202 x 320	
100	160	0	6	5	6	5	3	2	80	55	64	-	ZSF100E2S2	342 x 222 x 345	
100	160	0	6	5	6	5	-	-	120	55	64	-	ZSF100E2S2E	342 x 222 x 345	
100	160	0	6	5	6	5	3	2	120	55	64	-	ZSF100E2S2V	342 x 222 x 345	

ZS-H Series 2/2 Solenoid Valve(Normal Open)



ZS-H

2/2 Solenoid Valve (N.O.)



ZS-10H



ZS-15HS2

Product Features

- * 2/2 ways Solenoid valve, Normally open. Copper and stainless steel 304 valve selection
- * Multiple seals are available for different medium
- * Wide size range from 3/8" to 2", with both thread and flange connection
- * Diaphragm pilot solenoid valve, with lower working pressure
- * To reduce the power consumption of 80% energy-saving

Main Dimension

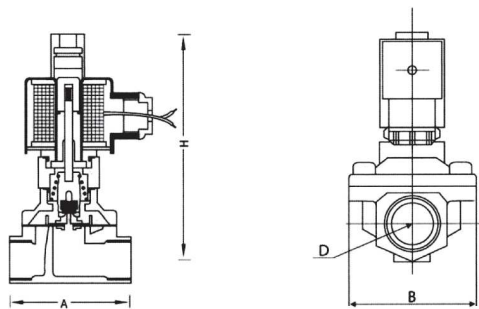

Specifications

Port size	Orifice (mm)	CV value	Pressure difference (Bar)								The maximum temperature of fluid (°C)	ZSH			ZSHN		Order code		Main dimension Length x Width x Height A x B x H (mm)
			Min. pressure		Max. working pressure							AC220	DC24V	DC24V	220VAC		50/60HZ		
			AC	DC	Air	Gas	Water	Hot water	Liquid	Light oil					≤20CST	Brass		Stainless steel 304	
3/8"	4.0	0.6	0	5	3	5	3	3	3	3	80	33	20	4	ZS10H-040E2	ZS10H-040E2S2	52.5 x 32.5 x 115		
	4.0	0.6	0	5	3	5	3	3	3	120	33	20	4	ZS10H-040E2E	ZS10H-040E2S2E	52.5 x 32.5 x 115			
	4.0	0.6	0	5	3	5	3	3	3	120	33	20	4	ZS10H-040E2V	ZS10H-040E2S2V	52.5 x 32.5 x 115			
	16	4.8	0	5	3	3	5	3	3	80	33	20	4	ZS10H-160E2	ZS10H-160E2S2	69 x 67 x 135			
	16	4.8	0	5	3	3	5	3	3	120	33	20	4	ZS10H-160E2E	ZS10H-160E2S2E	69 x 67 x 135			
	16	4.8	0	5	3	3	5	3	3	120	33	20	4	ZS10H-160E2V	ZS10H-160E2S2V	69 x 67 x 135			
1/2"	16	4.8	0	5	3	5	3	3	3	80	33	20	4	ZS15H-160E2	ZS15H-160E2S2	69 x 67 x 135			
	16	4.8	0	5	3	5	3	3	3	120	33	20	4	ZS15H-160E2E	ZS15H-160E2S2E	69 x 67 x 135			
	16	4.8	0	5	3	5	3	3	3	120	33	20	4	ZS15H-160E2V	ZS15H-160E2S2V	69 x 67 x 135			
	20	7.6	0	5	3	5	3	3	3	80	33	20	4	ZS20HE2	ZS20HE2S2	73 x 67 x 142			
	20	7.6	0	5	3	5	3	3	3	120	33	20	4	ZS20HE2E	ZS20HE2S2E	73 x 67 x 142			
	20	7.6	0	5	3	5	3	3	3	120	33	20	4	ZS20HE2V	ZS20HE2S2V	73 x 67 x 142			
3/4"	25	12	0	5	3	5	3	3	3	80	33	20	4	ZS25HE2	ZS25HE2S2	99 x 77.5 x 150			
	25	12	0	5	3	5	3	3	3	120	33	20	4	ZS25HE2E	ZS25HE2S2E	99 x 77.5 x 150			
	25	12	0	5	3	5	3	3	3	120	33	20	4	ZS25HE2V	ZS25HE2S2V	99 x 77.5 x 150			
	32	24	0	5	3	5	3	3	3	80	70	55	-	ZS32HE2	ZS32HE2S2	112 x 86.5 x 180			
	32	24	0	5	3	5	3	3	3	120	70	55	-	ZS32HE2E	ZS32HE2S2E	112 x 86.5 x 180			
	32	24	0	5	3	5	3	3	3	120	70	55	-	ZS32HE2V	ZS32HE2S2V	112 x 86.5 x 180			
1-1/4"	40	29	0	5	3	5	3	3	3	80	70	55	-	ZS40HE2	ZS40HE2S2	123 x 94 x 190			
	40	29	0	5	3	5	3	3	3	120	70	55	-	ZS40HE2E	ZS40HE2S2E	123 x 94 x 190			
	40	29	0	5	3	5	3	3	3	120	70	55	-	ZS40HE2V	ZS40HE2S2V	123 x 94 x 190			
	50	48	0	5	3	5	3	3	3	80	70	55	-	ZS50HE2	ZS50HE2S2	168 x 123 x 216			
	50	48	0	5	3	5	3	3	3	120	70	55	-	ZS50HE2E	ZS50HE2S2E	168 x 123 x 216			
	50	48	0	5	3	5	3	3	3	120	70	55	-	ZS50HE2V	ZS50HE2S2V	168 x 123 x 216			
Flange 4 hole	25	12	0	5	3	5	3	3	3	80	57	32	6	-	ZSF25HE2S2	140 x 115 x 180			
	25	12	0	5	3	5	3	3	3	120	57	32	6	-	ZSF25HE2S2E	140 x 115 x 180			
	25	12	0	5	3	5	3	3	3	120	57	32	6	-	ZSF25HE2S2V	140 x 115 x 180			
	32	24	0	5	3	5	3	3	3	80	70	55	-	-	ZSF32HE2S2	152 x 135 x 235			
	32	24	0	5	3	5	3	3	3	120	70	55	-	-	ZSF32HE2S2E	152 x 135 x 235			
	32	24	0	5	3	5	3	3	3	120	70	55	-	-	ZSF32HE2S2V	152 x 135 x 235			
	40	29	0	5	3	5	3	3	3	80	70	55	-	-	ZSF40HE2S2	152 x 145 x 240			
	40	29	0	5	3	5	3	3	3	120	70	55	-	-	ZSF40HE2S2E	152 x 145 x 240			
	40	29	0	5	3	5	3	3	3	120	70	55	-	-	ZSF40HE2S2V	152 x 145 x 240			
	50	48	0	5	3	5	3	3	3	80	70	55	-	-	ZSF50HE2S2	195 x 160 x 255			
	50	48	0	5	3	5	3	3	3	120	70	55	-	-	ZSF50HE2S2E	195 x 160 x 255			
	50	48	0	5	3	5	3	3	3	120	70	55	-	-	ZSF50HE2S2V	195 x 160 x 255			