

AS-Interface® components

FESTO

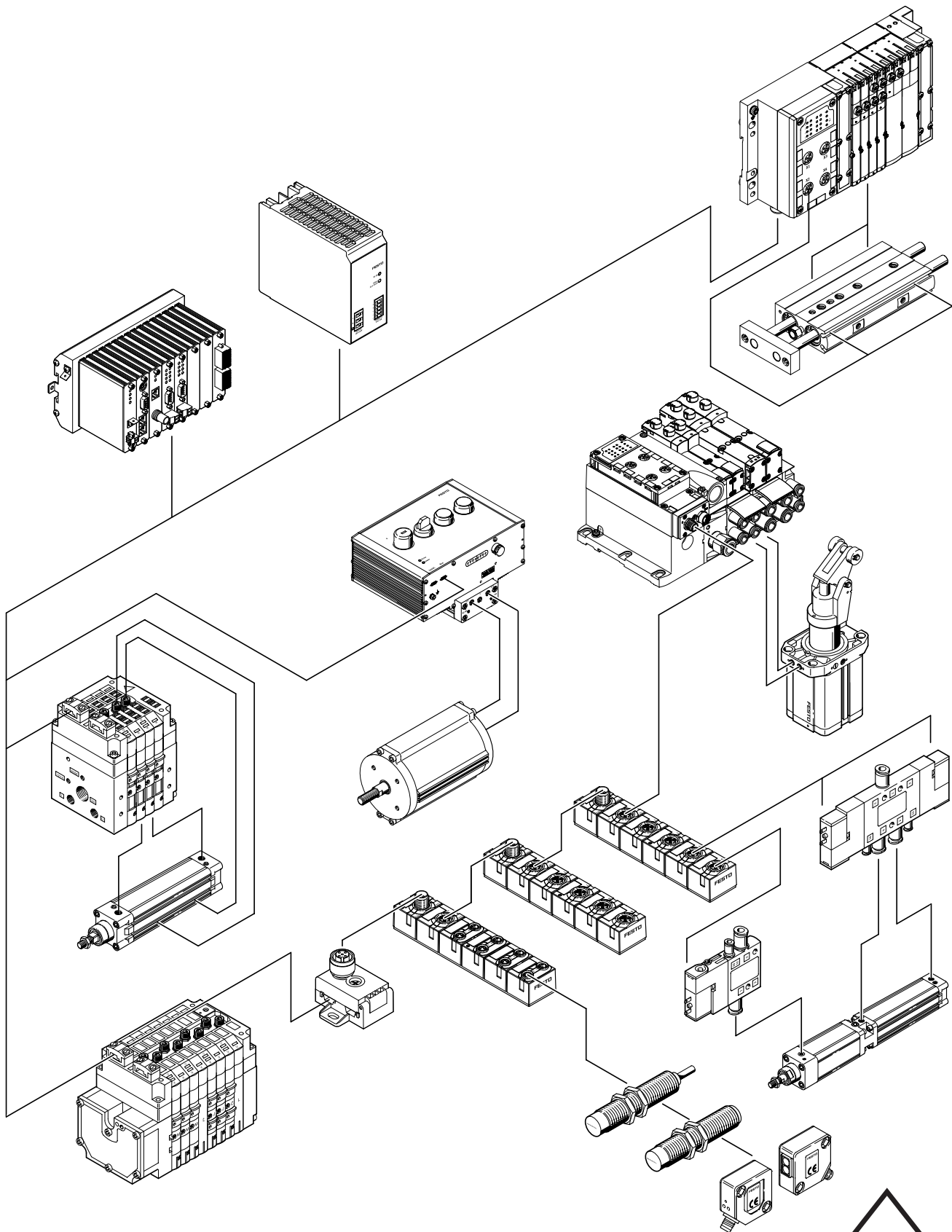

Overview of AS-Interface



Overview of AS-Interface

Basic principles and characteristics of the bus system

Introduction

AS-Interface is a manufacturer-independent, open installation system which is widely and increasingly used at the lowermost level of decentralised manufacturing and process automation.

Manufacturer independence and openness of the system are guaranteed by European standard EN 50295 and global standard IEC 62026-2.

Certified products bear the logo of the AS-International Association.

The AS-International Association and affiliated organisations represent the interests of all manufacturers involved with the AS-Interface.

Type

The AS-Interface system makes it possible to transfer data and energy using just one cable. This specific technology, with which stations are connected to the yellow cable, and the low connection costs mean that even stations with a small number of inputs and outputs (max. 8 I and 8 O per valve terminal with two chips) can be networked. This can save 26-40% on installation, depending on the type of system. This allows in particular individual or small groups of actuators, valves and sensors, to be connected to a higher-order controller in a cost-efficient way.

New developments in line with Spec 2.1, introduced in early 2000, such as the parameterisable profile 7.4 or AS-Interface Safety at Work, opened up new areas of implementation and created opportunities for significantly more efficient installation and networking concepts in many applications.

Spec 3.0, released in 2005, enabled new quantum leaps in what was possible, such as convenient control of analogue I/Os, more complex slaves, or serial transfer of text and data.

- Slaves in line with Spec 2.0 and 2.1 are also executable with Spec 3.0: the system is completely backwards compatible. Benefits of AS-Interface specification 3.0:
- All the benefits of the straightforward installation system since Spec. 2.0 are retained
- Up to 400% more I/O per master
- Improved diagnostics of faults in peripherals
- More functions within Spec. 2.1 and 3.0: e.g. simple integration of more complex 16-bit slaves, fast analogue modules, DTM integration, asynchronous serial protocol, Safety slaves

- Slave profiles for specific functions, as well as interchangeability. Mix between different manufacturers and products, e.g. for parameters or communications services.

AS-Interface with A/B mode gives you 100% more.

In A/B mode, each slave address is used twice. An output bit is used for A/B differentiation (case differentiation, see table). The cycle time is generally more than sufficient for pneumatic chains.

Specification Version	Inputs	Outputs	Bus cycle [ms]	No. of slaves		Sum of inputs/outputs
				Digital	Analogue	
2.0	4/4	4	5	31	31	248
2.1	4	3	10	62	31	434
3.0	4/8	4/8	20	62	62	992

CPX-AB-8-M8-3POL with connection socket M8, 3-pin

- Manufacturer independence
- No restrictions in terms of cable layout and/or topology
- Data and energy on one two-wire cable
- Interference-free
- Medium: Unscreened cable 2x 1.5 mm²
- Max. 4 inputs and 4 outputs per slave, with 31 slaves
- Data and power supply for up to 8 outputs per AS-Interface string
- Max. 4 inputs and 3 outputs per slave, with 62 slaves (A/B mode in line with Spec V2.1)
- Modules for control cabinets (IP20) and harsh industrial environments (IP65, IP67)
- 4 analogue inputs or outputs per slave, with 31 slaves
- Profile 7.3 Analogue values (16 bit) per slave (in line with Spec. V2.1)
- Profile 7.4 Parameterisable communications profile e.g. 16x 16 bit per slave (in line with Spec. V2.1)
- Profile 7.A.7 allows 4 bits each for digital inputs and outputs on an A/B slave. The 4 outputs are each transferred in two A/B bus cycles of 2 bits each. This extends the cycle time to 20 ms (worst case).
- Insulation displacement technology
- Cable length 100 m, can be extended to up to 200 m with an extension plug and to up to 500 m through the use of repeaters and other measures
- Highly effective error protection
- Easy commissioning
- Electronic address setting via the bus connection

Note

A master to Spec. 3.0 is essential for the use of slaves to Spec. 3.0.

Overview of AS-Interface

Basic features

Simple connection technology

- One cable for energy and data
- Cable geometry prevents reverse polarity
- No shielding due to error protection
- Insulation displacement connection technology guarantees Festo plug and work
- Alternative bus connection technology M12, 4-pin (standardised)

Ideal for pneumatic applications

Local control of small groups or decentralised, widely spread individual actuators means:

- Short tubing lengths
- High cycle rates
- Low air consumption.

Installation and communication are provided by components of the AS-Interface.

A powerful system component

The AS-Interface is positioned clearly beneath the fieldbuses in use and is thus not in competition with the fieldbuses but is a technically necessary and economically worthwhile addition.

Everything from a single source

Festo is your single source for the AS-Interface. This means:

- A single contact person
- Competent solutions from the market leader
- Convenient ordering system
- Complete delivery service
- Co-ordinated solutions for motion and control
- Worldwide service round the clock

Cycle rate optimisation

Decentralised solutions at the AS-Interface permit optimised electropneumatic control chains: perfectly matched valve switching time, cylinder diameter and stroke saves up to

- 20% cycle time with standard components
- 30% cycle time with faster switching valves
- 40% installation costs
- 50% air consumption/flow rate

Program summary

Valves

- Integrated inputs on valve terminals, e.g. CPV, MPA-S and VTSA/VTSA-F
- More inputs thanks to 4-way and 8-way input modules
- On request: Application-specific valves and integration solutions

System overview

Components

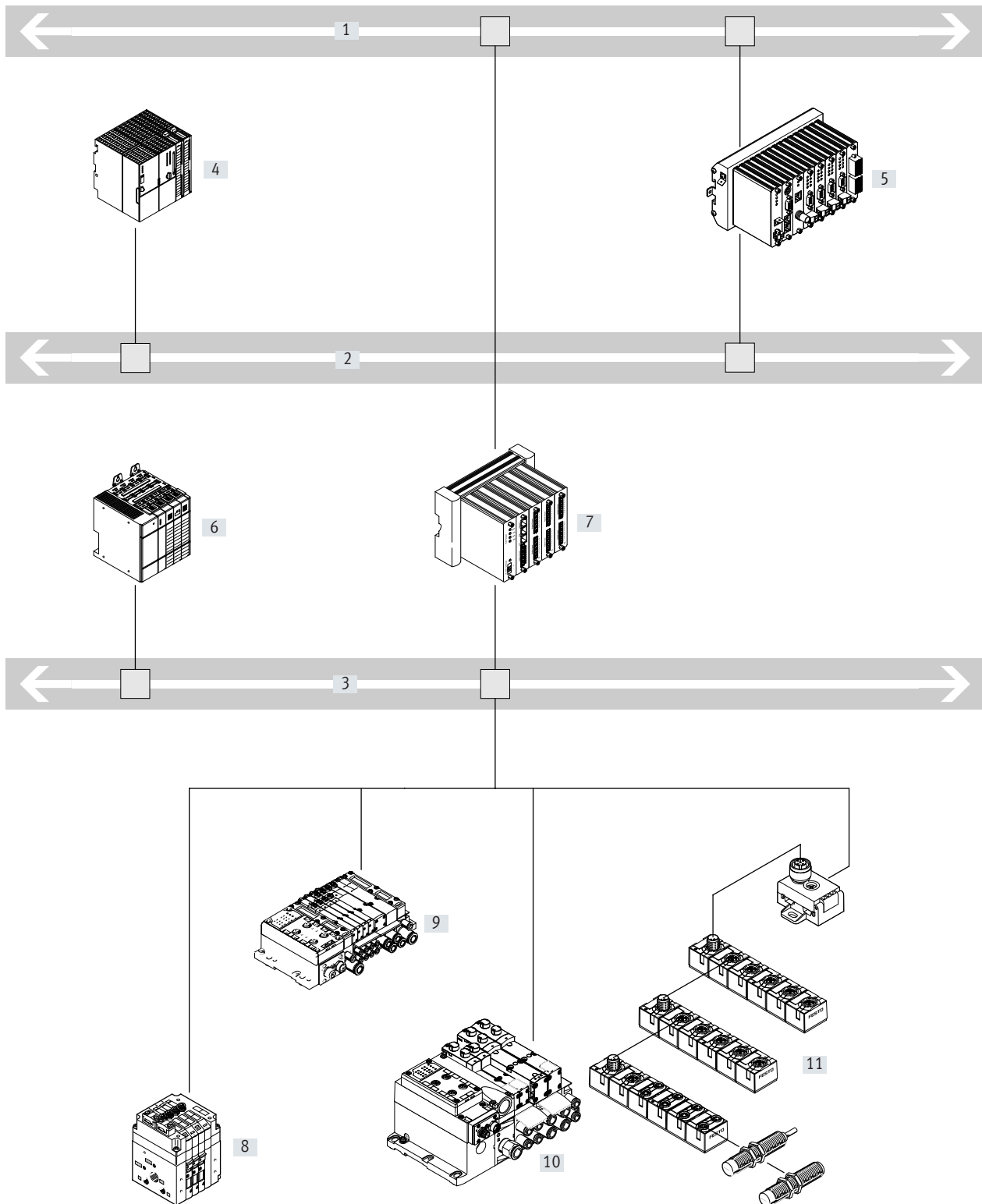

- | | | | |
|--|--|---|--|
| [1] Ethernet | [6] PLC with AS-Interface master to IP20 | [8] Valve terminal CPV with inputs, standard or A/B mode to Spec. 2.0, Spec. 2.1, Spec. 3.0 | [10] CPX compact VTSA/VTSA-F valve terminal with selectable inputs |
| [2] Fieldbus | [7] Industrial PC with AS-Interface master | [9] CPX compact MPA-S valve terminal with selectable inputs | [11] Compact I/O modules |
| [3] AS-Interface | | | |
| [4] PLC with fieldbus master | | | |
| [5] Industrial PC with fieldbus master | | | |

System overview

Application examples

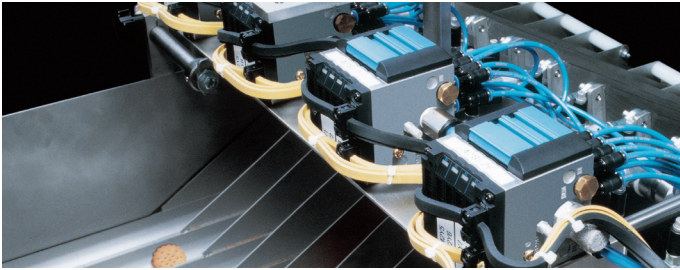

Sorting

Valve terminals MPA-S, VTSA/VTSA-F, and CPV:

Compact performance is synonymous with high performance and low weight. Mounting close to the drives simplifies installation, saves air and increases cycle rates.



Conveyor technology

Decentralised, widely distributed individual drives and sensors are commonly used in conveyor technology. The AS-Interface is particularly suitable in this environment.

Compact I/O modules connect one or two valves of any size and up to 4 sensors directly to the AS-Interface.



Packaging

With more complex machines, decentralised installation concepts are often required in a system for efficient design of the electrical installation.

Complex modules and upstream functions such as packaging are controlled by the AS-Interface in this case.

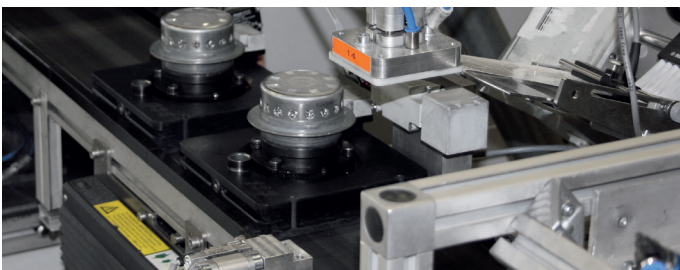

Assembly

Assembling, moving, handling: these often mean fast processes, compact installation conditions and reduced weight.

In such cases, compact I/O modules, valve terminals and perfectly matched drives are valuable features.



Process technology

Water treatment

Here too, automation and decentralised intelligence are innovative companions on more modern systems.

A compact I/O module is suitable for all valves with NAMUR interface.

The valve terminal VTSA/VTSA-F opens up new opportunities for flow processes in 24-hour non-stop operation. Vertical pressure shut-off plates enable valve changes under pressure (hot swap), thereby avoiding downtimes.

System overview

Slaves

Valves

- Simple solution incorporating compact EA modules
- Integrated inputs on valve terminals, e.g. CPV, MPA-S and VTSA/VTSA-F
- More inputs thanks to 4-way and 8-way input modules
- On request:
 - Application-specific valves and integration solutions

Accessories

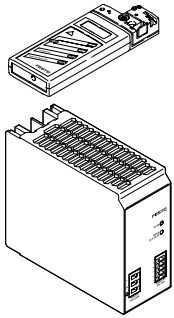

- Addressing device with convenient operating and diagnostics functions for the entire AS-Interface, e.g. on the fully installed network:
 - Change addresses
 - Set outputs
 - Read inputs
 - and much more
- Power supply unit for AS-Interface
- Primary switched-mode, modular power supply.
- Compact, modular and energy-saving power supply system for AS-Interface – with integrated earth-fault monitoring.
Load: 5 or 10 A
- Installation accessories for laying the flat cables

System overview

Valve interface variants

Bus node CTEU

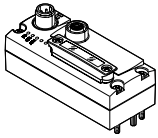

Incorporation of a range of valve terminals with I-Port interface in the AS-Interface:

- VTUG
- CPV

- VTUB-12
- VTOC
- MPA-L
- Universal connection technology M12

- Optional decentralised installation of the bus node with E-box CAPC
- Basic diagnostics: undervoltage, short circuit

Compact valve terminal CPV

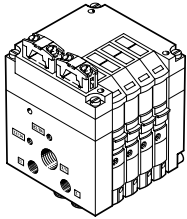

Maximum performance of 400 ... 1,600 l/min with minimal space requirement

- Valve combinations for 2, 4 or 8 valve slices
- Vacuum generation, relay and more in one modular assembly

- Ingenious tubing system via pneumatic multiple connector plate:
 - Rapid replacement of valve terminals
 - With control cabinet installation: no internal tubing required

- Inputs M8 included for each valve position
- Ex Zone 2, 22
- AS-i Spec. 2.0, 2.1 or 3.0

Modular, multi-functional valve terminal MPA-S

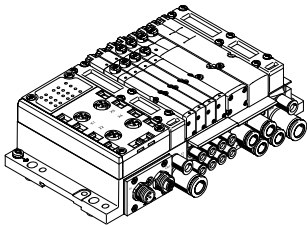

- Valves on a sub-base: Easy to swap individually
- MPA-S: robust and modular from 360 ... 700 l/min
- Flexible valve combinations for 2 ... 8 solenoid coils
- Valve terminals can be expanded at a later date

- MPA1, MPA14 and MPA2 valves can be mixed on one valve terminal for optimised flow rates and control chains
- All valve functions, plus regulator and pressure gauge for variable pressure setting at each valve position.

- 4 or 8 inputs with selectable connection technology
- Selectable connection technology on the bus. Flat cable with 4l/40 or M12 round cable with 4l/40 and 8l/80

Modular, multi-functional valve terminal VTSA/VTSA-F

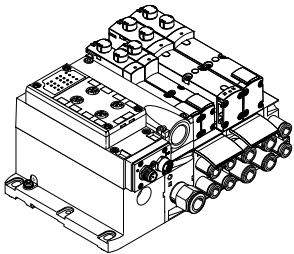

- Standard valves 18, 26, 42 and 52 mm to ISO 17504-2 and 5599-2 on a sub-base: easy to swap individually
- VTSA/VTSA-F: compact and modular from 550 ... 1500 l/min
- Flexible valve combinations for 1 ... 8 solenoid coils
- Valve terminals can be expanded at a later date

- 3 valve sizes can be mixed on one valve terminal for optimised flow rates and control chains
- All valve functions, multiple pressure zones, with regulator and pressure gauge for precision pressure at each valve position. Flow control valves, pressure shut-off plates for valve changes under pressure (hot swap) and further components for vertical stacking.

- 4 or 8 inputs with selectable connection technology
- Selectable connection technology on the bus. Flat cable with 4l/40 or M12 round cable with 4l/40 and 8l/80

Compact I/O modules

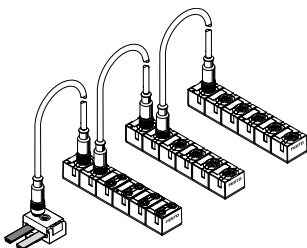

- Highly compact modules
- Robust, encapsulated electrics
- Bus and auxiliary power supply 2x M12 looped through

- Inputs 200 mA
- Outputs 1 A

- 8 inputs M8
- 4 inputs and 3 outputs M12

Data sheet – Bus node CTEU-AS

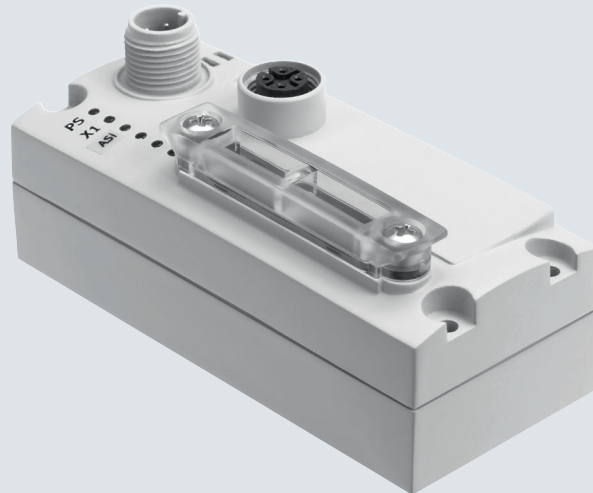
**Interface module CTEU-AS**

The bus node handles communication between the valve terminal and a higher-order AS-Interface® master.

General

The module has a system and load supply, a bus connection and a connection to the valve terminal with serial I-Port interface.

Versions

The module has basic diagnostic functions. It has 3 integrated LEDs for on-site display. A maximum of 2 byte inputs and 2 byte outputs are transmitted in the cyclic process image.

Application

- Activation of up to 16 solenoid coils per valve terminal
- Automatic addressing
- Automatic detection of the number of connected valves

Data sheet – Bus node CTEU-AS

System overview

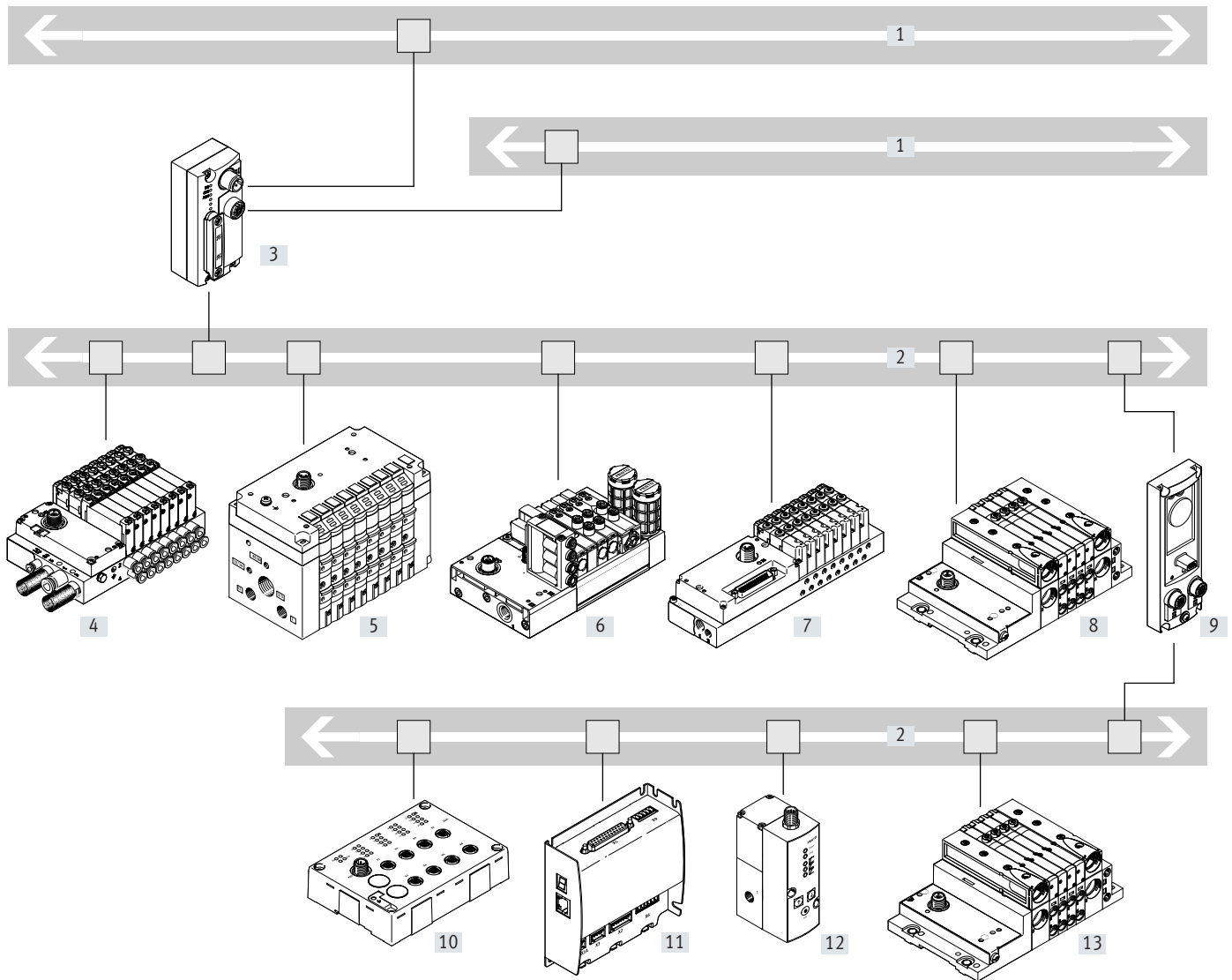

- | | | | |
|-----------------------------------|---|--|---|
| [1] AS-Interface | [8] Valve terminal MPA-L | <ul style="list-style-type: none"> • Communication with the higher-order controller via fieldbus • Use a bus node CTEU compatible with the fieldbus protocol | <ul style="list-style-type: none"> • Up to 24 valve positions (depending on the valve terminal) • Flow rate of up to 1200 l/min (depending on the valve terminal) |
| [2] I-Port | [9] Electrical connection block CAPC | | |
| [3] CTEU bus node (I-Port master) | [10] Input module CTSL | [11] Motor controller CMMO-ST | |
| [4] Valve terminal VTUG | [12] Proportional-pressure regulator VPPM | [13] Valve terminal MPA-L | |
| [5] Valve terminal CPV | | | |
| [6] Valve terminal VTUB-12 | | | |
| [7] Valve terminal VTOC | | | |

Connection of valve terminals to a higher-order I-Port master

VTUG	CPV	VTUB-12	VTOC
<ul style="list-style-type: none"> • Up to 24 valve positions • Flow rate of up to 1200 l/min 	<ul style="list-style-type: none"> • Up to 8 valve positions • Flow rate of up to 1200 l/min 	<ul style="list-style-type: none"> • Up to 35 valve positions • Flow rate of up to 400 l/min 	<ul style="list-style-type: none"> • Up to 24 valve positions • Flow rate of up to 10 l/min

MPA-L

- Up to 32 valve positions
- Flow rate of up to 870 l/min

Data sheet – Bus node CTEU-AS



The bus node handles communication between the valve terminal and a higher-order AS-Interface® master.

- Activation of up to 16 solenoid coils per valve terminal
- Automatic addressing
- Automatic detection of the number of connected valves



General technical data

General technical data		
Fieldbus interface 1		
Protocol		AS-Interface
Function		Incoming bus connection
		Power supply
Type		AS-Interface
Connection type		Plug
Connection technology		M12x1, A-coded to EN 61076-2-101
Number of pins/wires		4
Internal cycle time	[ms]	10
Fieldbus interface 2		
Function		Bus connection outgoing
		Power supply
Connection type		Socket
Connection technology		M12x1, A-coded to EN 61076-2-101
Number of pins/wires		4
Inputs/outputs		
Max. address capacity inputs	[byte]	2
Max. address volume for outputs	[byte]	2

Data sheet – Bus node CTEU-AS

General data		
Device-specific diagnostics		System diagnostics
		Undervoltage
		Communication error
Parameterisation		Watchdog enable
		Watchdog disable
Additional functions		Emergency message
		Acyclic data access via SDO
Configuration support		None
Control elements		DIL switch
LED display	Product-specific	PS: Operating voltage for electronics and load supply
		X1: System status of module at I-Port 1
	Fieldbus-specific	AS-i: AS-Interface mode

Technical data – Electrics		
Nominal operating voltage	[V DC]	30
Operating voltage range	[V DC]	20 ... 31.6
Intrinsic current consumption at nominal operating voltage	[mA]	Typically 50
Max. power supply	[A]	4

Technical data – Mechanical components		
Type of mounting		On electrical connection block
		On electrical interface
Product weight	[g]	90 (without AS-i plug and without interlinking module)
Grid dimension	[mm]	40
Dimensions W x L x H	[mm]	40 x 91 x 50

Materials	
Housing	PA
Note on materials	RoHS-compliant
	Contains paint-wetting impairment substances

Operating and environmental conditions		
Ambient temperature	[°C]	-5 ... +50
Storage temperature	[°C]	-20 ... +70
Corrosion resistance class CRC ¹⁾		2
CE marking (see declaration of conformity) ³⁾		To EU EMC Directive ²⁾
Certification		c UL us listed (OL)
Degree of protection		IP65/IP67
Note on degree of protection		In assembled state
		Unused connections sealed

1) Corrosion resistance class CRC 2 to Festo standard FN 940070

Moderate corrosion stress. Indoor applications in which condensation can occur. External visible parts with primarily decorative surface requirements which are in direct contact with a normal industrial environment.

2) For information about the area of use, see the EC declaration of conformity at: www.festo.com/sp → Certificates.

If the devices are subject to usage restrictions in residential, commercial or light-industrial environments, further measures for the reduction of the emitted interference may be necessary.

3) Additional information is available at www.festo.com/sp → Certificates.

Data sheet – Bus node CTEU-AS

Dimensions

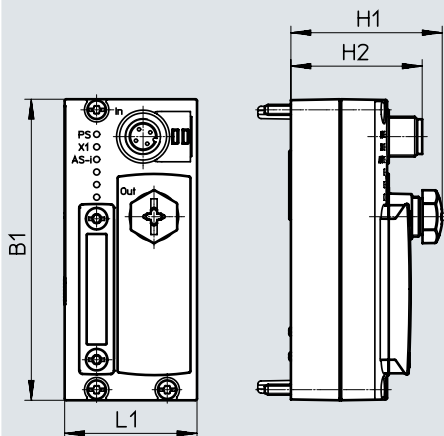

Type	B1	H1	H2	L1
CTEU-AS	91	45.3	39.7	40

Pin allocation





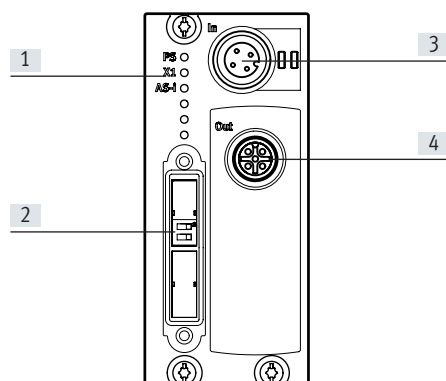

	Pin	Allocation
M12 plug, AS-Interface In		
	1	AS-Interface +
	2	24 V load voltage supply
	3	AS-Interface -
	4	0 V load voltage supply
M12 socket, AS-i Out		
	1	AS-Interface +
	2	24 V load voltage supply
	3	AS-Interface -
	4	0 V load voltage supply

Connection and display components

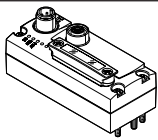

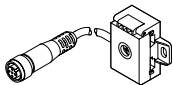
- [1] Status LED (operating status/
diagnostics)
- [2] DIL switch
- [3] M12 plug, AS-Interface bus and
auxiliary power supply (AS-i In)
- [4] M12 socket, AS-Interface bus and
auxiliary power supply (AS-i Out)

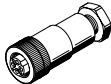
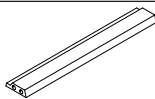
Data sheet – Bus node CTEU-AS

Ordering data		Part no.	Type
Bus node			
	AS-Interface bus node	572555	CTEU-AS
Cable socket with load voltage supply			
	Flat cable	4-pin socket, M12x1, A-coded	–
	Flat cable	4-pin socket, M12x1, A-coded	1 m
Cable socket without load voltage supply			
	Flat cable	4-pin socket, M12x1, A-coded	572225
	Flat cable, screw terminal	4-pin straight socket, M12x1, A-coded	18789
Flat cable			
	AS-Interface flat cable	Yellow	18940
		Black	18941
	Cable sleeve for insulating and sealing the flat cable	165593	ASI-KT-FK
	Cable cap for insulating and sealing the flat cable	18787	ASI-KK-FK

Valve terminals CPV

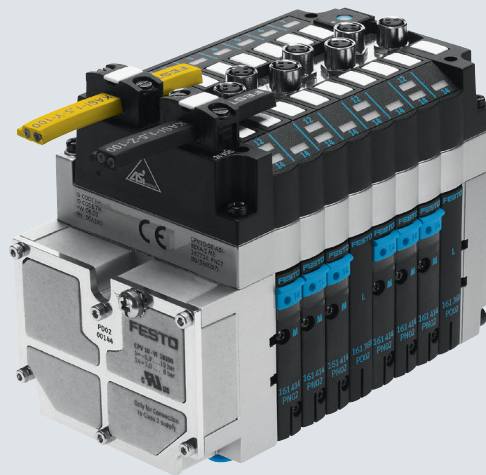

Valve terminals CPV with AS-Interface – Valve configuration options

Valve terminals CPV with AS-Interface can be configured with a wide range of valve slices. The system supports a maximum of 8 outputs and 8 inputs per AS-Interface slave.

This gives the following basic valve slice configuration options (see tables on following page). Vacant positions can be configured instead of valve slices at any position.

General

- With or without 24 V DC auxiliary power supply for solenoid coils (EMERGENCY-STOP circuitry), depending on bus interface
- Solutions with and without integrated inputs
- Width 10, 14 or 18 mm

Versions

- 2, 4 or 8 valve slices
- Optionally with 4 or 8 inputs
 - Standard mode (SPEC V2.0)
 - A/B mode (SPEC V2.1)
 - A/B mode (SPEC V3.0, profile 7.A.7)

- Optionally with floating relay outputs
- Valves with integrated separation of ducts 1 and 11
- Separator plates for creating pressure zones
- Suitable for vacuum
- Vacant positions for subsequent extension
- Optionally with pneumatic multiple connector plate

Application

- Cost-effective connection of 2, 4 or 8 valve slices to the AS-Interface
- Comprehensive range of valve functions
- Decentralised machine and system structures, for example
 - in handling technology
 - in conveyor technology
 - in the packaging industry
 - in sorting systems
 - in upstream machine functions

Note

Please follow the link below for more details on the various pneumatic functions.

→ Internet: cpv

Valve terminals CPV

Types of valve terminal with AS-Interface									
Code	Type	Valve slices	Solenoid coils	Inputs (M8 connection)	Auxiliary power supply		Size		
					With	None	CPV10	CPV14	CPV18
AZ	CPV1x-GE-ASI-2-Z	2	4	–	■	–	■	■	■
AZ	CPV18-GE-ASI-4-Z	4	4	–	■	–	–	–	■
AE/AO	CPV1x-GE-ASI-4E4A (-Z)	4	4	4	■	■	■	■	–
AE	CPV1x-GE-ASI-8E8A-Z	8	8	8	■	–	■	■	–
BE	CPV1x-GE-ASI-4E3A (-Z)	4	3	4	■	–	■	■	–
BE	CPV1x-GE-ASI-8E6A-Z	8	6	8	■	–	■	■	–
CE	CPV1x-GE-ASI-4E4A-Z-M8-CE	4	4	4	■	–	■	■	–
CE	CPV1x-GE-ASI-8E8A-Z-M8-CE	8	8	8	■	–	■	■	–

1) The load voltage (auxiliary power supply via the black cable) can be connected/disconnected separately.

Permissible combinations for valve position allocation								
Type	Slave n				Slave n+1			
	0	1	2	3	4	5	6	7
CPV1x-GE-ASI-2-Z	M	M						
	J	M						
	M	J						
	J	J						
CPV18-GE-ASI-4-Z	M	M	M	M				
CPV1x-GE-ASI-4E4A (-Z) CPV10-GE-ASI-4A (-Z) CPV14-GE-ASI-4A (-Z)	M	M	M	M				
	J	Vacant position	M	M				
	M	M	J	Vacant position				
	J	Vacant position	J	Vacant position				
CPV1x-GE-ASI-4E3A -Z ¹⁾	M	M	M	Vacant position				
	J	Vacant position	M	Vacant position				
CPV1x-GE-ASI-8E8A-Z ¹⁾ CPV1x-GE-ASI-8E8A-Z-CE ¹⁾	M	M	M	M	M	M	M	M
	J	Vacant position	M	M	M	M	M	M
	M	M	J	Vacant position	M	M	M	M
	J	Vacant position	J	Vacant position	M	M	M	M

	M	M	M	M	M	M	M	M
	M	M	M	M	J	Vacant position	M	M
	M	M	M	M	M	M	J	Vacant position
CPV1x-GE-ASI-8E6A-Z ¹⁾	M	M	M	Vacant position	M	M	M	Vacant position
	M	M	M	Vacant position	J	Vacant position	M	Vacant position
	J	Vacant position	M	Vacant position	M	M	M	Vacant position
	J	Vacant position	M	Vacant position	J	Vacant position	M	Vacant position

- 1) – Valve slices with 2 outputs must be configured at positions 0, 2, 4, 6 (positions 0, 4 only with A/B mode).
 – Valve slices with 2 outputs are always followed by a vacant position.
 – Slaves n and n+1 can be configured independently of one another. This gives a total of 16 different configuration options.
- M Valve slice with single solenoid valve or alternatively a different valve slice with one output
 J Valve slice with double solenoid valve or alternatively a different valve slice with two outputs

Valve terminals CPV with integrated inputs, to SPEC V2.0

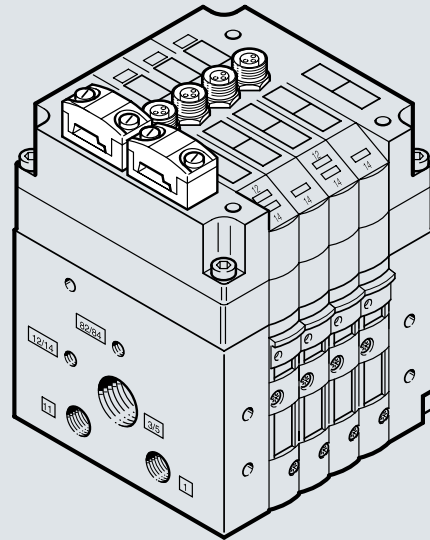

Valve terminals CPV with integrated inputs, to specification V2.0

General

- Cubic design for exceptional performance and low weight
- Highly flexible thanks to various pneumatic functions (valve variants), different pressure ranges, vacuum switches and the option of integrated vacuum generation.
- Floating relay outputs (optional)
- Connection for auxiliary power supply for emergency off conditions
- Degree of protection IP65

LED displays for:

- Status indication for inputs
- Switching status indications for valves
- PWR LED (power)
- FAULT LED (fault)

Versions

- Width 10 and 14 mm
- 4 or 8 inputs
- 4 or 8 valve positions
- Up to four pressure zones
- Suitable for vacuum

- Vacuum generation
- Various valve functions on one valve terminal, e.g.
 - 2x 3/2-way valve
 - 5/2-way valve, single solenoid
 - 5/2-way valve, double solenoid
 - 5/3-way valve
 - 2x 2/2-way valve
 - Valves with integrated separation of ducts 1 and 11
 - Separator plate
 - Vacant position

- Additional function (screwed onto valve slice)
 - One-way flow control valve
- Various mounting options

Application

- Flexible and cost-effective connection of 4 or 8 valve slices and up to 8 sensors to the M8 inputs, to Spec. 2.0, 31 slaves, bus cycle max. 5 ms. Executable on all masters from Spec. 2.0 or later.

 **Note**

Please follow the link below for more details on the various pneumatic functions.

→ Internet: cpv

Valve terminals CPV with integrated inputs, to SPEC V2.0

Technical data		CPV-...-4E4A-Z-M8	CPV-...-4E4A-M8	CPV-...-8E8A-Z-M8
Type				
Part no.		Order via ident. code/valve terminal configurator		
Code		AE	AO	AE
Valves	Number of valve slices/coils	4	4	8
	Valve width [mm]	10/14		
	Setting of the valve configuration	Integrated DIL switches		
	External voltage supply 24 V DC	Yes	No	Yes
	Digital inputs	4	4	8
	Connection technology	M8, 3-pin		
	Sensor supply via AS-Interface	Short-circuit and overload protected		
	Sensor connection	2-wire and 3-wire sensors		
	Design	IEC 1131-2, type 2		
	Input circuit	PNP (positive switching)		
AS-Interface connection	Connection technology	AS-Interface flat cable plug (included in the scope of delivery)		
	Voltage range [V DC]	26.5 ... 31.6, reverse polarity protected		
	Residual ripple [mVss]	20		
	Current consumption, inputs [mA]		CPV10/14	
	• In 0 status	7	61/95	40
	• In 1 status (no current consumption by sensors)	35	89/123	96
	• In 1 status (max. current consumption by sensors)	240	191/225	278
• Max. per input		200	200	200
	• Max. per valve			
	– When switching on		25/38.75	
– Following current reduction		8.75/12.5		
Load voltage connection	Connection technology	AS-Interface flat cable plug (version turned 180° must be ordered separately)		
	Nominal voltage [V DC]	24 ±10%		
	Residual ripple [Vss]	4		
	Current consumption, valves	CPV10/14	No load voltage connection	CPV10/14
	• When switching on [mA]	108/176		200/310
• Following current reduction [mA]	42/72		70/100	
LED displays	ASI LED	Power/green		
	AUX-PWR LED	Auxiliary power supply/green	None	Auxiliary power supply/green
	FAULT LED	Fault LED/red		
	Inputs	Green		
	Valves	Yellow		
General information	Degree of protection (to EN 60529)	IP65 (fully assembled)		
	Electromagnetic compatibility			
	• Emitted interference	Tested to EN 55011, limit value class B		
	• Immunity to interference	Tested to DIN EN 61000-4-2, DIN EN 61000-4-4 and EN V 50140		
	CE marking	Yes, to EU Directive 89/336/EEC		
	Certification	c UL us Recognized (OL)		
	Temperature range [°C]	Operation: -5 ... +50; storage/transport: -20 ... +70		
	Materials	Housing: Die-cast aluminium; Cover: Reinforced PA; Seal: NBR, CR		
	Note on materials	RoHS-compliant		
	Dimensions	→ 31		
	Weight	→ 31		
Pneumatic data	→ Internet: cpv			
AS-Interface data	Ident. code	F _H (ID = F _H ; ID1 = F _H ; ID2 = F _H)		
	IO code	7 _H		
	Profile	S-7.F		

Valve terminals CPV with integrated inputs, for A/B mode, to SPEC V2.1

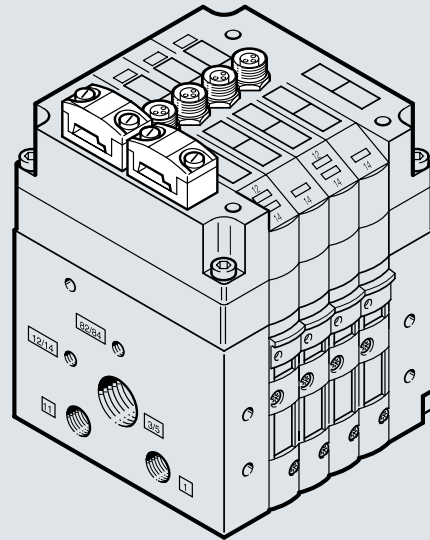
Valve terminals CPV with integrated inputs, for A/B mode, to specification V2.1¹⁾**General**

- A/B mode increases the performance of each master
 - 100% more inputs (248 instead of 124)
 - 50% more outputs (186 instead of 124)
- Cubic design for exceptional performance and low weight
- Highly flexible thanks to various pneumatic functions (valve variants), different pressure ranges, vacuum switches and the option of integrated vacuum generation.

- Floating relay outputs (optional)
- Connection for auxiliary power supply for emergency off conditions
- Degree of protection IP65

LED displays for:

- Status indication for inputs
- Switching status indications for valves
- PWR LED (power)
- FAULT-LED (fault)²⁾

Versions

- Width 10 and 14 mm
- 4 or 8 inputs
- 3 or 6 valve positions
- Up to four pressure zones
- Suitable for vacuum
- Vacuum generation
- Various valve functions on one valve terminal, e.g.
 - 2x 3/2-way valve
 - 5/2-way valve, single solenoid
 - 5/2-way valve, double solenoid
 - 5/3-way valve
 - 2x 2/2-way valve
 - Valves with integrated separation of ducts 1 and 11
 - Separator plate
 - Vacant position

- Additional function (screwed onto valve slice)
 - One-way flow control valve
- Various mounting options

Application

- AS-i networks with A/B mode to SPEC 2.1 and SPEC 3.0, 62 slaves, bus cycle 10 ms
- Flexible and cost-effective connection of 3 or 6 valve slices and up to 8 sensors to the M8 inputs

Note

Please follow the link below for more details on the various pneumatic functions.

→ Internet: cpv

1) Slave compatible with SPEC 3.0
2) Peripherals faults to SPEC V2.1 not yet implemented

Valve terminals CPV with integrated inputs, for A/B mode, to SPEC V2.1

Technical data		CPV-...-4E3A-Z-M8	CPV-...-8E6A-Z-M8
Type			
Part no.		Order via ident. code/valve terminal configurator	
Code		BE	BE
Valves	Number of valve slices/coils	3	6
	Valve width [mm]	10/14	
	Setting of the valve configuration	Integrated DIL switches	
	External voltage supply 24 V DC	Yes	
	Digital inputs	4	8
	Connection technology	M8, 3-pin	
	Sensor supply via AS-Interface	Short-circuit and overload protected	
	Sensor connection	2-wire and 3-wire sensors	
	Design	IEC 1131-2, type 2	
	Input circuit	PNP (positive switching)	
AS-Interface connection	Connection technology	AS-Interface flat cable plug (included in the scope of delivery)	
	Voltage range [V DC]	26.5 ... 31.6, reverse polarity protected	
	Residual ripple [mVss]	20	
	Current consumption, inputs [mA]		
	• In 0 status	7	40
	• In 1 status (no current consumption by sensors)	35	96
	• In 1 status (max. current consumption by sensors)	137	278
• Max. per input	200	200	
Load voltage connection	Connection technology	AS-Interface flat cable plug (version turned 180° must be ordered separately)	
	Nominal voltage [V DC]	24 ±10%	
	Residual ripple [Vss]	4	
	Current consumption, valves	CPV10/14	CPV10/14
	• When switching on [mA]	81/132	150/233
• Following current reduction [mA]	32/54	53/75	
LED displays	ASI LED	Power/green	
	AUX-PWR LED	Auxiliary power supply/green	
	FAULT LED	Fault LED/red	
	Inputs	Green	
	Valves	Yellow	
General information	Degree of protection (to EN 60529)	IP65 (fully assembled)	
	Electromagnetic compatibility		
	• Emitted interference	Tested to EN 55011, limit value class B	
	• Immunity to interference	Tested to DIN EN 61000-4-2, DIN EN 61000-4-4 and EN V 50140	
	CE marking	Yes, to EU Directive 89/336/EEC	
	Temperature range [°C]	Operation: -5 ... +50; storage/transport: -20 ... +70	
	PWIS criterion	Free of paint-wetting impairment substances	
	Materials	Housing: Die-cast aluminium; Cover: Reinforced PA; Seal: NBR, CR	
	Note on materials	RoHS-compliant	
	Dimensions	→ 31	
	Weight	→ 31	
	Pneumatic data	→ Internet: cpv	
AS-Interface data	Ident. code	ID = A _H ; ID1 = 7 _H ; ID2 = E _H	
	IO code	7 _H	
	Profile	S-7.A.E	

Valve terminals CPV with integrated inputs, for A/B mode, to SPEC V3.0

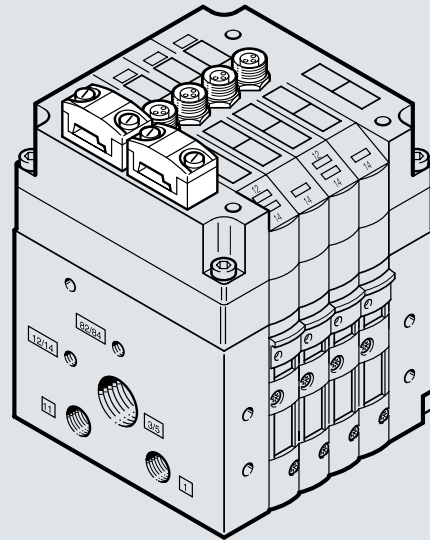

Valve terminals CPV with integrated inputs, for A/B mode, to specification V3.0, profile 7.A.7

General

- A/B mode increases the performance of each master
 - 100% more inputs
 - (248 instead of 124)
 - 100% more outputs
 - (248 instead of 124)
- Cubic design for exceptional performance and low weight
- Highly flexible thanks to various pneumatic functions (valve variants), different pressure ranges, vacuum switches and the option of integrated vacuum generation.

- Floating relay outputs, optional
- Connection for auxiliary power supply for emergency off conditions
- Degree of protection IP65

LED displays for:

- Status indication for inputs
- Switching status indications for valves
- PWR LED (power)
- FAULT LED (fault)

Versions

- Width 10 and 14 mm
- 4 or 8 inputs
- 4 or 8 valve positions
- Up to four pressure zones
- Suitable for vacuum
- Vacuum generation
- Various valve functions on one valve terminal, e.g.
 - 2x 3/2-way valve
 - 5/2-way valve, single solenoid
 - 5/2-way valve, double solenoid
 - 5/3-way valve
 - 2x 2/2-way valve
 - Valves with integrated separation of ducts 1 and 11
 - Separator plate
 - Vacant position

- Additional function (screwed onto valve slice)
 - One-way flow control valve
- Various mounting options

Application

- AS-i networks with A/B mode to SPEC 3.0, profile 7.A.7, 62 slaves, bus cycle max. 20 ms
- Flexible and cost-effective connection of 4 or 8 valve slices and up to 8 sensors to the M8 inputs.

 **Note**

Slaves to Spec. 3.0 need an AS-i master to Spec. 3.0; these automatically detect the new slave profiles.

Please follow the link below for more details on the various pneumatic functions.

→ Internet: cpv

Valve terminals CPV with integrated inputs, for A/B mode, to SPEC V3.0

Technical data		CPV-...-4E4A-Z M8-CE	CPV-...-8E8A-Z M8-CE
Type			
Part no.	Order via ident. code/valve terminal configurator		
Code	CE		CE
Valves	Number of valve slices/coils	4	8
	Valve width [mm]	10/14	
	Setting of the valve configuration	Integrated DIL switches	
	External power supply [V DC]	24	
	Digital inputs	4	8
	Connection technology	M8, 3-pin	
	Device-specific diagnostics	Short circuit/overload of inputs	
	Sensor connection	2-wire and 3-wire sensors	
	Input characteristics	IEC 1131-2, type 2	
	Input switching logic	PNP (positive switching)	
AS-Interface connection	Connection technology	AS-Interface flat cable plug (included in the scope of delivery)	
	Number of slaves per device	1	2
	Voltage range [V DC]	26.5 ... 31.6, reverse polarity protected	
	Residual ripple [mVss]	20	
	Debounce time at inputs (for 24 V) [ms]	Typically 3	
	Set using AS-Interface addressing device	1A ... 31A (0) 1B ... 31B	
	Switching level [V]	Signal 0 ≤ 5 Signal 1 ≥ 11	
	Current consumption, inputs [mA]		
	• In 0 status	20	40
	• In 1 status (no current consumption by sensors)	Max. 48	Max. 96
• Max. per input	200	200	
Load voltage connection	Connection technology	AS-Interface flat cable plug (version turned 180° must be ordered separately)	
	Nominal voltage [V DC]	24 ±10%	
	Residual ripple [Vss]	4	
	Current consumption of valves (type-dependent)	CPV10/14	CPV10/14
	• When switching on [mA]	Max. 115/175	Max. 240/460
• Following current reduction [mA]	Max. 55/75	Max. 95/120	
LED displays	ASI LED	Power/green	
	AUX-PWR LED	Auxiliary power supply/green	
	FAULT LED	Fault LED/red	
	Inputs	Green	
	Valves	Yellow	
General information	Degree of protection (to EN 60529)	IP65 (fully assembled)	
	Relative humidity [%]	0 ... 95 (non-condensing)	
	Temperature range [°C]	Operation: -5 ... +50; storage/transport: -20 ... +70	
	Materials	Housing: Die-cast aluminium; Cover: Reinforced PA; Seal: NBR, CR	
	Dimensions	→ 31	
	Weight	→ 31	
	Pneumatic data	→ Internet: cpv	
AS-Interface data	Ident. code	ID = A _H ; ID1 = 7 _H ; ID2 = 7 _H	
	IO code	7 _H	
	Profile	S-7.A.7	

Valve terminals CPV without inputs, to SPEC 2.1

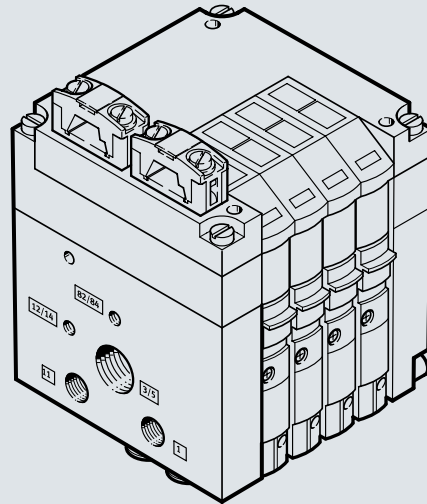
Valve terminals CPV without inputs, to specification 2.1¹⁾**General**

- Cubic design for exceptional performance and low weight
- Highly flexible thanks to various pneumatic functions (valve variants), different pressure ranges, vacuum switches and the option of integrated vacuum generation
- Floating relay outputs (optional)
- Connection for auxiliary power supply for emergency off conditions
- Degree of protection IP65

LED displays for:

- Switching status indications for valves
- PWR LED (power)
- FAULT-LED (fault)²⁾
- Valve diagnostics: short circuit or wire break at valve solenoid coil, valve not switching (no movement of the plunger)

Versions

- Width 10, 14 and 18 mm
- 2 or 4 valve positions
- Up to two pressure zones
- Suitable for vacuum
- Vacuum generation

- Valve terminal with 4 valve positions:
 - With or without 24 V DC auxiliary power supply for solenoid coils (EMERGENCY-STOP circuitry)
 - The auxiliary power supply is always integrated and can be subsequently switched off using the DIL switch.
- Various valve functions on one valve terminal, e.g.
 - 2x 3/2-way valve
 - 5/2-way valve, single solenoid
 - 5/2-way valve, double solenoid
 - 5/3-way valve
 - 2x 2/2-way valve

- Valves with integrated separation of ducts 1 and 11
- Separator plate
- Vacant position
- Additional function (screwed onto valve slice)
 - One-way flow control valve
- Extensive mounting options

Application

- Flexible and cost-effective connection of 2 or 4 valve slices, 31 slaves, bus cycle max. 5 ms

Note

Please follow the link below for more details on the various pneumatic functions.

→ Internet: cpv

1) Slave compatible with SPEC 3.0

2) Valve terminal with 4 valve positions: peripherals fault to SPEC 2.1 implemented
valve terminal with 2 valve positions: peripherals fault not implemented

Valve terminals CPV without inputs, to SPEC V2.1

Technical data		CPV-...-2-Z	CPV-...-4-Z ¹⁾
Type			
Part no.		Order via ident. code/valve terminal configurator	
Code		AZ	AS/AZ
Valves	Number of valve slices/coils	2/4	4/4
	Valve width	10 mm	■
		14 mm	■
		18 mm	■
	Setting of the valve configuration	None (permanently assigned)	CPV10/14 integrated DIL switch, CPV 18 ³⁾
External voltage supply 24 V DC	Yes	Yes ²⁾	
			Can be set using DIL switch
AS-Interface connection	Connection technology	AS-Interface flat cable plug (must be ordered separately)	
	Voltage range [V DC]	26.5 ... 31.6, reverse polarity protected	
	Residual ripple [mVss]	20	
	Current consumption of all valves	CPV10/14/18	CPV10/14/18
	• Without current reduction [mA]	25/25/25	25/25/25
	• With current reduction [mA]	25/25/25	25/25/25
Load voltage connection	Connection technology	AS-Interface flat cable plug (must be ordered separately)	
			Blanking plug for sealing the unused connection enclosed
	Nominal voltage [V DC]	24 ±10%	
	Residual ripple [Vss]	4	
	Max. starting current	CPV10/14/18	CPV10/14/18
	• Before current reduction [mA]	108/176/320	110/165/246
	• Following current reduction [mA]	48/72/120	35/40/100
LED displays	PWR LED	Power/green	
	FAULT LED	Fault LED/red	Peripherals fault LED/red Valve diagnostics: short circuit or wire break at valve solenoid coil, valve not switching (no movement of the plunger)
	Valves	Yellow	
General information	Degree of protection (to EN 60529)	IP65 (fully assembled)	
	Electromagnetic compatibility		
	• Emitted interference	Tested to EN 55011, limit value class B	
	• Immunity to interference	Tested to DIN EN 61000-4-2, DIN EN 61000-4-4 and EN V 50140	
	CE marking	Yes, to EU Directive 89/336/EEC	
	Temperature range [°C]	Operation: -5 ... +50; storage/transport: -20 ... +70	
	Materials	Housing: Die-cast aluminium; Cover: Reinforced PA; Seal: NBR, CR	
	Dimensions	→ 31	
	Weight	→ 31	
	Pneumatic data	→ Internet: cpv	
AS-Interface data	Ident. code	F _H	
	IO code	8 _H	
	ID2 code	F _H	E _H (F _H for CPV18)
	Profile	S-8.F	S-8.FE
	Parameter P3		1 = enable 2 = disable
	CPV valve diagnostic function		
Default	1 for CPV with valve diagnostics		

1) New as of HW version 0105: single or double solenoid valves can be configured using a DIL switch

2) With or without 24 V DC auxiliary power supply for solenoid coils (EMERGENCY-STOP circuitry). The auxiliary power supply is always integrated and can be switched on/off using the DIL switch.

3) None (permanently assigned)

Data sheet – Valve terminals CPV

Overview of connections/displays – CPV with AS-Interface

CPV-...-2-Z / ASI-4-(Z)

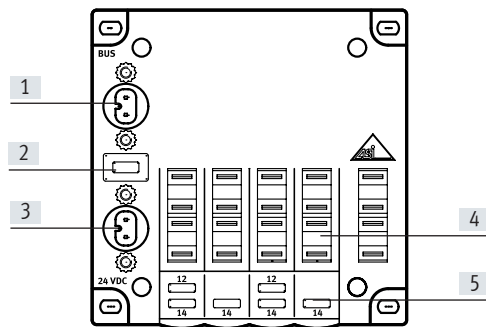

- [1] AS-Interface bus connection
- [2] PWR LED (power, green)
FAULT LED (fault, red)
- [3] Auxiliary power supply for valves
(optional)
- [4] Inscription labels
- [5] LED display for valves

CPV-...-4E4A(Z) / 4E/3A-...- / 4E/4A-...-CE

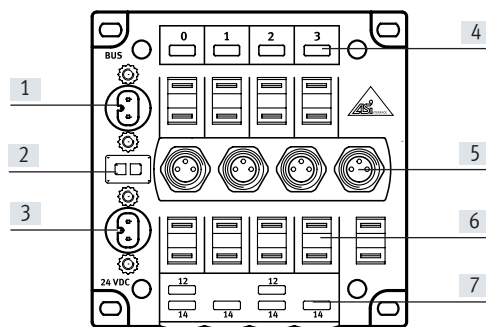

- [1] AS-Interface bus connection
- [2] PWR LED (power, green)
FAULT LED (fault, red)
- [3] Auxiliary power supply for valves
(optional)
- [4] LED display for inputs (green)
- [5] Sensor connections
- [6] Inscription labels
- [7] LED display for valves (yellow)

CPV-...-8E8A-Z / 8E/6A / 8E/8A-...-CE

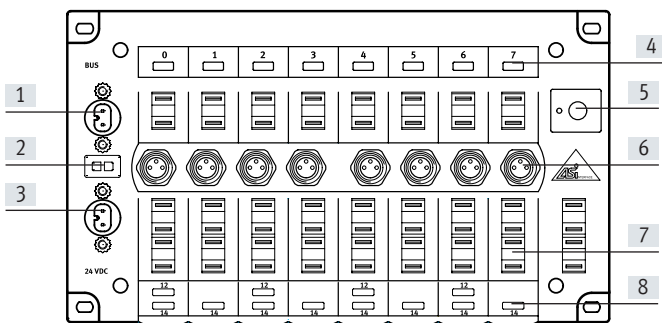

- [1] AS-Interface bus connection
- [2] PWR LED (power, green)
FAULT LED (fault, red)
- [3] Auxiliary power supply for valves
- [4] LED display for inputs (green)
- [5] Address selector button with LED
- [6] Sensor connections
- [7] Inscription labels
- [8] LED display for valves (yellow)

Data sheet – Valve terminals CPV

Weights [g] – Valve terminal CPV with AS-Interface			
Type	CPV10	CPV14	CPV18
Electrical connection block with AS-Interface connection			
• with 2 valve positions	85	130	275
• with 4(3) valve positions	110	175	355
• with 8(6) valve positions	200	300	
End plate, pack of 2	160	280	740
Pneumatic multiple connector plate			
• on CP valve terminal with 2 valve positions	120	270	520
• on CP valve terminal with 4 valve positions	165	390	750
• on CP valve terminal with 6 valve positions	225	510	870
• on CP valve terminal with 8 valve positions	270	630	1300
Flat plate silencer	147	234	–
Relay plate	35	55	–
Blanking plate	25	45	90
Separator plate	25	45	90
Valve sub-base/vacuum generator	65	110	260
Function element: one-way flow control valve	25	54	125

Dimensions – CPV with AS-Interface

Download CAD data → www.festo.com

Without integrated inputs

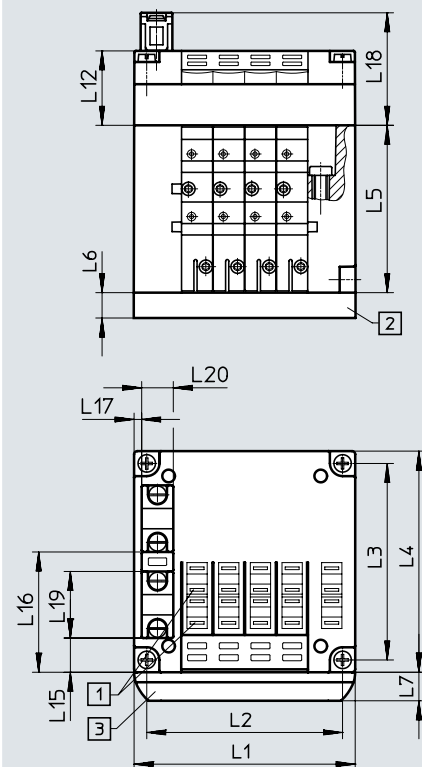

- [1] Slots for inscription labels
- [2] Pneumatic multiple connector plate
- [3] Holder for inscription labels

		L1	L2	L3	L4	L5	L6	L7	L12	L14	L15	L16	L17
CPV10	2 valves	50	41.8	62	71	52.8	15	9.5	–	10.9	38.1	2.5	35.5
	4 valves	70	61.8	62	71	52.8	15	9.5	23.5	10.9	38.1	2.5	35.5
CPV14	2 valves	68	58	78	89	58.8	20	9.5	–	14	52	5	35.5
	4 valves	96	86	78	89	58.8	20	9.5	23.5	14	52	5	35.5
CPV18	2 valves	96	85.5	106.5	118	73	20	9.5	–	27.4	68.2	10.4	40
	4 valves	132	121.5	106.5	118	73	20	9.5	28	27.4	68.2	10.4	40

Data sheet – Valve terminals CPV

Dimensions – CPV with AS-Interface

Download CAD data → www.festo.com

CPV10/14 with integrated inputs

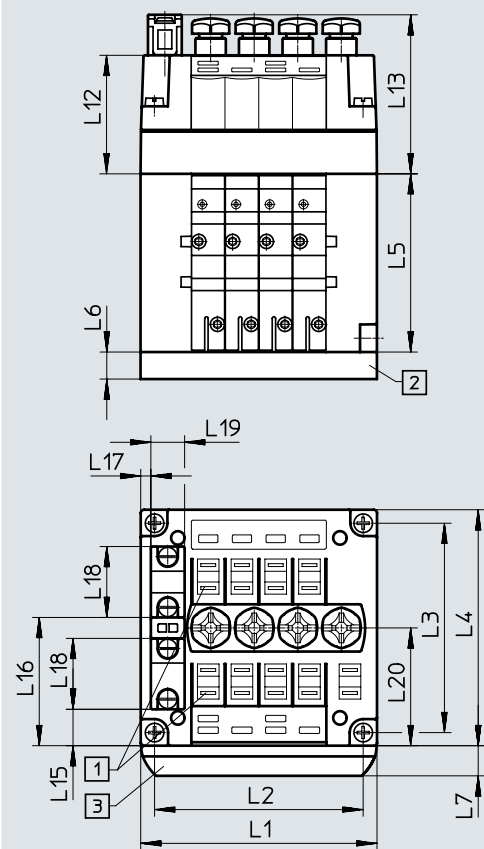

- [1] Slots for inscription labels
- [2] Pneumatic multiple connector plate
- [3] Holder for inscription labels (CPV10/14-VI-BZ-T... or CPV10/14-VI-ST-T...)

CPV10 with integrated inputs

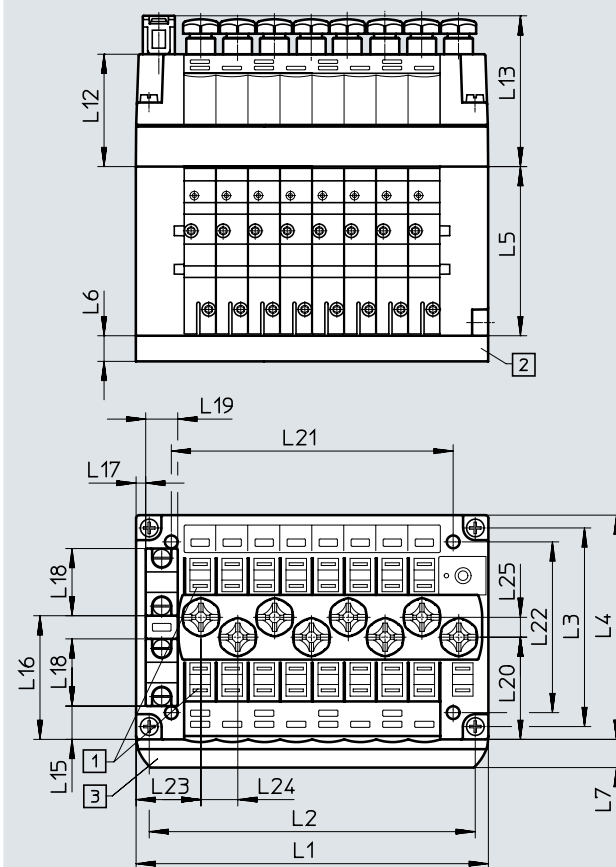

- [1] Slots for inscription labels
- [2] Pneumatic multiple connector plate
- [3] Holder for inscription labels (CPV10-VI-BZ-T... or CPV10-VI-ST-T...)

		L1	L2	L3	L4	L5	L6	L7	L18	L19	L20	L21
CPV10	4 valves	70	61.8	62	71	52.8	15	9.5	10.9	38.1	35	3
	8 valves	110	101.8						10.4	38.6	31.9	
CPV14	4 valves	96	86	78	89	58.8	20	9.5	18.8	46.8	43.3	5

Data sheet – Valve terminals CPV

Dimensions – CPV with AS-Interface

Download CAD data → www.festo.com



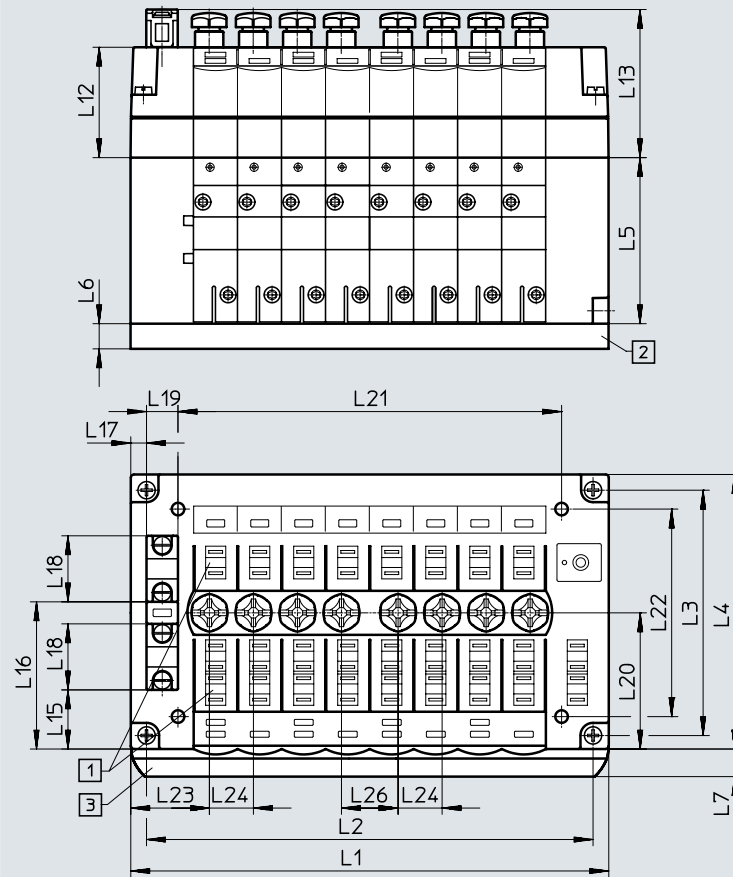





CPV14 with integrated inputs

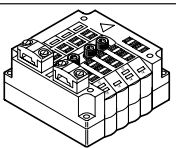
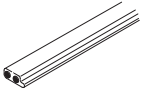

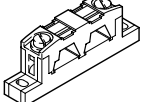
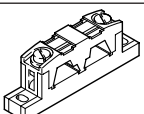

- [1] Slots for inscription labels
- [2] Pneumatic multiple connector plate
- [3] Holder for inscription labels (CPV14-VI-BZ-T... or CPV14-VI-ST-T...)

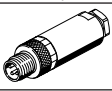
		L1	L2	L3	L4	L5	L6	L7	L18	L19	L20	L21
CPV14	8 valves	152	142	78	89	58.8	20	9.5	18.8	46.8	46.3	5

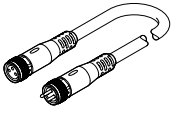
Data sheet – Valve terminals CPV

Ordering data		Designation	Part no.	Type
Bus connection				
	Electrical interface CPV10	4 valve positions	552559	CPV10-GE-ASI-4E4A-Z-M8-CE
		8 valve positions	552560	CPV10-GE-ASI-8E8A-Z-M8-CE
	Electrical interface CPV14	4 valve positions	552561	CPV14-GE-ASI-4E4A-Z-M8-CE
		8 valve positions	552562	CPV14-GE-ASI-8E8A-Z-M8-CE
Bus connection				
	AS-Interface flat cable 100 mm	Yellow	18940	KASI-1.5-Y-100
		Black	18941	KASI-1.5-Z-100
	Flat cable socket		18785	ASI-SD-FK
	Flat cable socket	Turned 180°	196089	ASI-SD-FK180
	Flat cable dummy plug		196090	ASI-SD-FK-BL
	AS-Interface flat cable distributor	Rotatable cable	18786	ASI-KVT-FK
	AS-Interface flat cable distributor	Symmetrical cable	18797	ASI-KVT-FK-S
	Cable cap for flat cable (pack of 50)		18787	ASI-KK-FK
	Cable sleeve (pack of 20)		165593	ASI-KT-FK
Sensor plug				
	Straight plug, M8, 3-pin	Screw-in	192009	SEA-3GS-M8-S
		Solderable	18696	SEA-GS-M8
	Cover cap (pack of 10)	M8	177672	ISK-M8
Connecting cable				
	Modular system for a choice of connecting cables → Internet: nebu		–	NEBU-...
	Straight plug M8, 3-pin, straight socket M8, 3-pin	0.5 m	541346	NEBU-M8G3-K-0.5-M8G3
		1.0 m	541347	NEBU-M8G3-K-1-M8G3
		2.5 m	541348	NEBU-M8G3-K-2.5-M8G3
		5.0 m	541349	NEBU-M8G3-K-5-M8G3

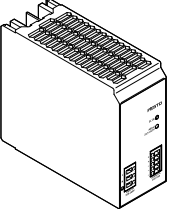
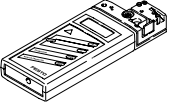
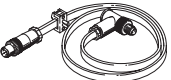
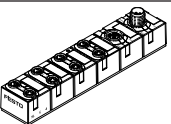
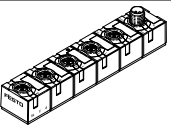
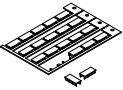
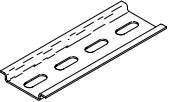
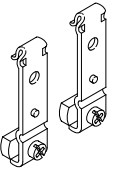
Data sheet – Valve terminals CPV

Ordering data		Designation	Part no.	Type
Other				
	Primary switched-mode, modular power supply 24 V DC power supply	5 A	2247681	CACN-3A-1-5
		10 A	2247682	CACN-3A-1-10
	Addressing device (power supply plug included in the scope of delivery)		18959	ASI-PRG-ADR
	Addressing cable		18960	KASI-ADR
	AS-Interface input module for 8 inputs M8		542124	ASI-8DI-M8-3POL
	AS-Interface input/output module for 4 inputs/3 outputs M12		542125	ASI-4DI3DO-M12X2-5POL-Z
	Inscription labels	6x10 mm (pack of 64)	18576	IBS-6x10
		9x20 mm (pack of 20)	18182	IBS-9x20
	H-rail to EN 60715		35430	NRH-35-2000
	Mounting for H-rail		162556	CPV10/14-VI-BG-NRH-35
			163291	CPV18-VI-BG-NRH-35
User documentation				
	CPV pneumatics manual	German	165100	P.BE-CPV-DE
		English	165200	P.BE-CPV-EN
		French	165130	P.BE-CPV-FR
		Italian	165160	P.BE-CPV-IT
		Spanish	165230	P.BE-CPV-ES

MPA-S valve terminal



MPA-S valve terminals with AS-Interface – Valve configuration options

MPA-S valve terminals with AS-Interface can be flexibly configured with a wide range of valves. The system supports a maximum of 8 outputs (solenoid coils) and 8 inputs per valve terminal. This gives the following basic valve configuration options (see tables on following page).

 **Note**

Please follow the link below for more details on the various pneumatic functions.

→ Internet: mpa-s

General

- Solutions with integrated inputs
- Width 10 mm, 14 mm or 20 mm
- With or without 24 V DC auxiliary power supply for solenoid coils (EMERGENCY-STOP circuitry) in the case of the 4I/4O version. The auxiliary power supply is always integrated in the version with 8 inputs and cannot be subsequently switched off using the DIL switch.
- Selectable bus connection technology
 - Flat cable for AS-Interface with 4I/4O version
 - 4-pin M12 round plug¹⁾ with 4I/4O and 8I/8O version
- Selectable addressing
 - Via bus connection (M12 or flat cable)

Versions

- 2 to 8 valves, freely configurable
- With 4 or 8 inputs
- M12, M8, quick connection, spring-loaded terminal or Sub-D connection technology
- Separating seals for creating pressure zones
- Suitable for vacuum
- Subsequent extensions either
 - via unused valve positions
 - by converting the valve terminal

Application

- Flexible and cost-effective connection of 2 or 8 valves (max. 8 solenoid coils) with input feedback.
- Decentralised machine and system structures, e.g.
 - in handling technology
 - in conveyor technology
 - in the packaging industry
 - in sorting systems
 - suitable for energy chains thanks to connection via round cables

1) Matching cable distributor for flat cable to M12 → 42

MPA-S valve terminal – Connection technology and addressing

Types of valve terminal with AS-Interface										
Type	Valves	Solenoid coils	Inputs	Corresponds to Spec	Extended addressing range	Auxiliary power supply can be switched off		Width		
						Yes	No	10 mm	14 mm	20 mm
VMPA-ASI-EPL-E-4E4A-Z	4	4	4	2.1	–	■	–	■	■	■
VMPA-ASI-EPL-G-4E4A-Z	4	4	4	2.1	–	■	–	■	■	■
VMPA-ASI-EPL-EU-4E4A-Z	4	4	4	2.1	–	■	–	■	■	■
VMPA-ASI-EPL-GU-4E4A-Z	4	4	4	2.1	–	■	–	■	■	■
VMPA-ASI-EPL-E-8E8A-Z	8	8	8	2.1	–	–	■	■	■	■
VMPA-ASI-EPL-G-8E8A-Z	8	8	8	2.1	–	–	■	■	■	■
VMPA-ASI-EPL-EU-8E8A-Z	8	8	8	2.1	–	–	■	■	■	■
VMPA-ASI-EPL-GU-8E8A-Z	8	8	8	2.1	–	–	■	■	■	■
VMPA-ASI-EPL-E-8E8A-CE	8	8	8	3.0	■	–	■	■	■	■
VMPA-ASI-EPL-G-8E8A-CE	8	8	8	3.0	■	–	■	■	■	■
VMPA-ASI-EPL-EU-8E8A-CE	8	8	8	3.0	■	–	■	■	■	■
VMPA-ASI-EPL-GU-8E8A-CE	8	8	8	3.0	■	–	■	■	■	■

Permissible combinations for valve position allocation				
Type	Slave n			
	0	1	2	3
4I/4O MPA1 and MPA14 – M only (up to 4 valves per sub-base)	M	M	M	M
	M	M	M	L
	M	M	L	L
	M	L	L	L
4I/4O MPA2 (2 valves per sub-base)	M	M	M	M
	J	M	–	–
	M	J	–	–
	J	J	–	–

- 1) All valve slices are freely configurable, limited by the number of solenoid coils supported (4 or 8).
 A cover plate can be used instead of a valve slice, a cover plate can be used as reserve position for one or two solenoid coils.
- M Valve slice with single solenoid valve or alternatively a different valve slice with one output
 J Valve slice with double solenoid valve or alternatively a different valve slice with two outputs
 L Vacant position

MPA-S valve terminal – Connection technology and addressing

Permissible combinations for valve position allocation								
Type	Slave n plus slave n+1							
	0	1	2	3	4	5	6	7
8I/8O MPA1 and MPA14 (up to 4 valves per sub-base)	M	M	M	M	M	M	M	M
	M	M	M	L	M	M	M	L
	J	J	J	J	-	-	-	-

	J	J	J	J	-	-	-	-
	J	J	J	M	-	-	-	-
	J	J	M	M	-	-	-	-

	J	J	L	L	-	-	-	-
8I/8O MPA2 (2 valves per sub-base)	M	M	M	M	M	M	M	M
	M	M	M	L	M	M	M	L

	J	J	J	J	-	-	-	-
	J	J	J	M	-	-	-	-
	J	J	M	M	-	-	-	-

	J	J	M	M	M	M	-	-
	J	J	M	M	M	L	-	-

	M	M	M	M	J	J	-	-

- 1) All valve slices are freely configurable, limited by the number of solenoid coils supported (4 or 8).
A cover plate can be used instead of a valve slice, a cover plate can be used as reserve position for one or two solenoid coils.
- M Valve slice with single solenoid valve or alternatively a different valve slice with one output
J Valve slice with double solenoid valve or alternatively a different valve slice with two outputs
L Vacant position

MPA-S valve terminal – Connection technology and addressing

Installation: Selectable connection technology for AS-Interface

Support for flat cables

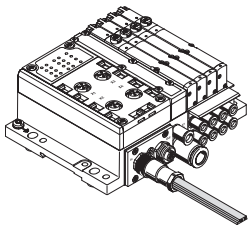

- Straightforward installation with flat cable in the more protected area
- Fast installation technology with standard AS-Interface cables
- Standard installation at the AS-Interface using yellow flat cable possible with MPA-S version 41/40

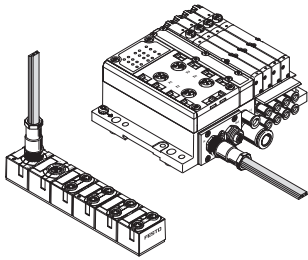

Standard installation at the AS-Interface flat cable

Support for round cables

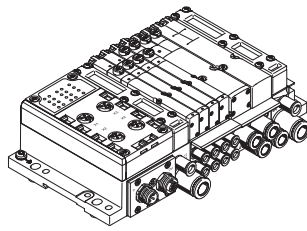

Local round cable wiring for areas with permanently higher loads:

- Consistently high humidity
- Need for flexible installation with one cable
- Use in energy chains with highly flexible lines

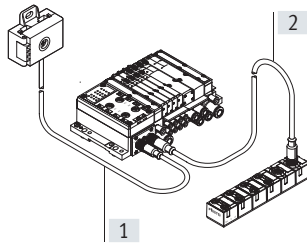

- [1] Pre-assembled M12 round cable, 1 m, polyurethane
- [2] Optional cable for additional slave, e.g. highly flexible cable for energy chains or PVC cable for applications requiring resistance to cleaning agents

Addressing

Addressing device

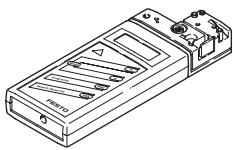

Using the addressing device according to SPEC V2.1, it is possible to scan the AS-Interface from any chosen point in the network. At all connected stations:

- Slave addresses can be read/changed
- ID and IO codes can be read out
- Parameters can be read/changed
- Input/output data can be read and written (setting outputs)
- Error messages can be read out and quickly recognised.

AS-Interface connections

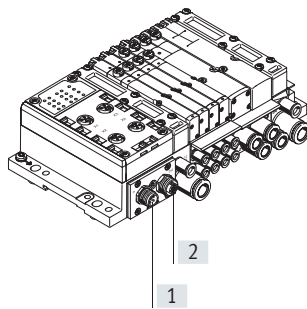

- [1] M12 plug for AS-Interface and incoming auxiliary supply
- [2] M12 socket for AS-Interface and outgoing auxiliary supply

Extended addressing range

The extended addressing range enables a total of 62 slaves to be operated on an AS-Interface master. The master as well as the slaves must be designed for the extended addressing range in order to be able to exploit the full number of slaves.

With the extended addressing range, two slaves share one address. Standard slaves do not have this capability. They can be connected to a master with an extended addressing range, but also occupy a full address.

In other words, up to 62 slaves with an extended addressing range can be connected to a master with an extended addressing range, but only 31 standard slaves.

Slaves with an extended addressing range, like standard slaves, can be connected to a standard master, but must be configured as "A" slaves.

MPA-S valve terminal – Connection technology and addressing

AS-Interface flat cable distributor to round cable

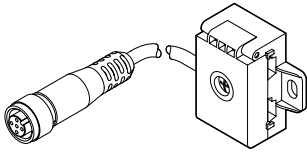

Alternative connection concepts

- Connection technology for AS-Interface for yellow and optionally for black flat cable
- Passive conversion of signals on M12 socket and round cable with M12 socket
- Pre-assembled round cable 1 m, PUR
- Optional PVC extension cable, or other suitable cable of any length, via additional M12 socket

Selecting the cable

It is easy to implement optimised connection technologies at the AS-Interface by choosing the appropriate cable:

- Flat cables for all standard applications with insulation displacement technology to reduce installation effort
- Round cables for applications with different requirements, e.g.:
 - Energy chains with a small radius and increased requirement for highly flexible cables

- Applications with consistently high humidity
- Applications in which a lot of cleaning takes place and in which cables that are resistant to cleaning agents are required (PUR, PVC or other cables)
- Cabling with standards (M12) preferred

Easy to assemble

Direct assembly on the wall or machine frame.

Supplementary, compact I/O modules

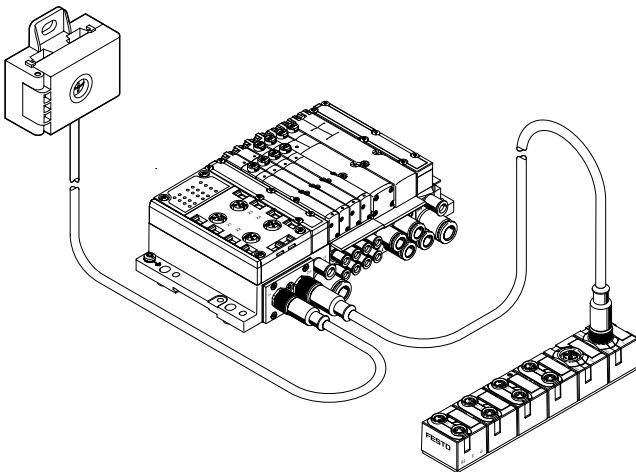

The compact I/O modules can be used to supplement the valve terminal MPA-S. The following are available:

- 8 inputs M8
- 4 inputs/3 outputs M12

Key features – Display and operation

Display and operation

Each solenoid coil is allocated an LED that indicates its signal status.

- Indicator 12 shows the switching status of the coil for output 2
- Indicator 14 shows the switching status of the coil for output 4

Manual override

The manual override (MO) enables the valve to be switched when not electrically activated or energised.

The valve is switched by pushing the manual override. The set switching status can also be locked by rotating the manual override (code R or as accessory).

Alternatives:

- A covering (code N or as an accessory) prevents the manual override from being locked. The manual override can then only be activated by pushing it.

- A covering (code V) can be fitted over the manual override to prevent it from being accidentally activated.

Pneumatic connection and control elements

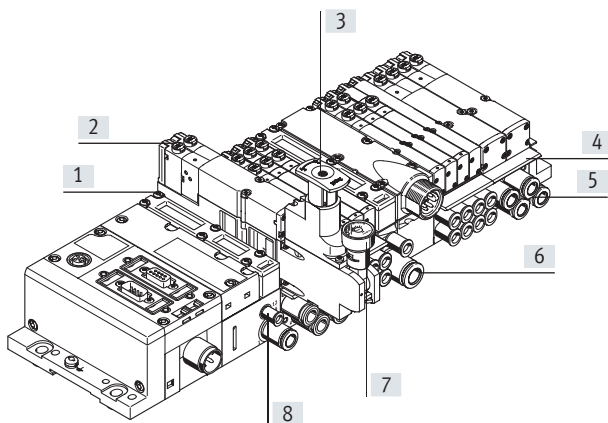

- [1] Flat plate silencer for exhaust port 3/5
- [2] Manual override (for each pilot solenoid coil, non-detenting or non-detenting/detenting)
- [3] Adjusting knob for optional pressure regulator plate
- [4] Inscription label holder for sub-base
- [5] Working ports 2 and 4, per valve position
- [6] Supply port 1
- [7] Pressure gauge (optional)
- [8] Ports 12 and 14 for supplying the external pilot air

Note
A manually operated valve (manual override) cannot be reset electrically. Conversely, an electrically actuated valve cannot be reset using the mechanical manual override.

Electrical connection and display components on the AS-Interface

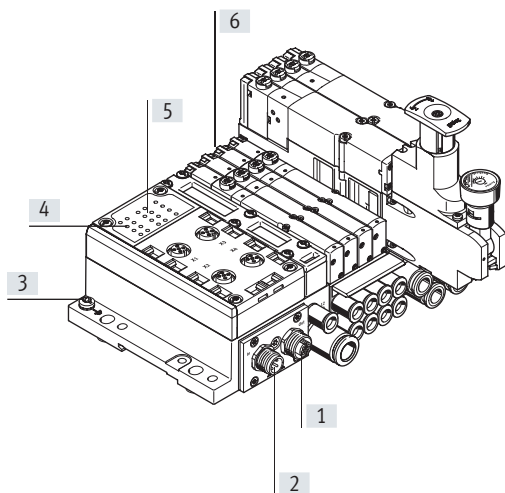

- [1] M12 socket for AS-Interface bus and auxiliary power supply (AS-i Out)
- [2] M12 plug for AS-Interface bus and auxiliary power supply (AS-i In)
- [3] Earth terminal
- [4] Status LEDs for inputs
- [5] Status LEDs for AS-Interface
- [6] Diagnostic LEDs for valves

Data sheet – Valve terminal MPA-S

General technical data		VMPA-...-4E4A-Z		VMPA-...-8E8A-Z		VMPA-...-8E8A-CE		
Type								
Part no.		Order via ident. code/valve terminal configurator						
Valves	Number of solenoid coils	4		8				
	Valve width [mm]	10, 14, 20						
	External voltage supply 24 V DC	Set using DIL switch		Yes				
Inputs	Number of digital inputs	4		8				
	Connection technology	M12 5-pin, M8 3-pin, Harax, CageClamp, Sub-D						
	Sensor supply via AS-Interface	Short-circuit and overload protected						
	Sensor connection	2-wire and 3-wire sensors						
	Design	IEC 1131-2, type 02						
	Input circuit	PNP (positive switching)						
AS-Interface connection	Connection technology	M12 connection ²⁾						
	Voltage range [V DC]	26.5 ... 31.6, reverse polarity protected						
	Residual ripple [mVss]	20						
	Current consumption, inputs [mA]	Without auxiliary power supply	≤25		≤25		≤25	
		With auxiliary power supply	≤25		≤25		≤25	
	Basic electronic load	≤25		≤25		≤25		
	Total input current	350		350		350		
	Total output current (valves incl. LED) [mA]	MPA1: 270 MPA14: – MPA2: 533		MPA1: 540 MPA14: – MPA2: 1065		MPA1: 540 MPA14: – MPA2: 1065		
Load voltage connection	Connection technology	M12 connection ²⁾						
	Voltage range [V DC]	21.6 ... 26.4						
	Residual ripple [Vss]	4						
Current consumption of valves per solenoid coil	Max. starting current (at 24 V) [mA]	MPA1: ≤80 MPA14: – MPA2: ≤100						
	Following current reduction (approx. 25 ms) [mA]	MPA1: ≤25 MPA1: – MPA2: ≤20						
LED displays	ASI LED	Green						
	AUX-PWR LED	Green						
	FAULT LED	Red						
	Inputs	Green						
	Valves	Yellow						
General information	Materials	Die-cast aluminium, PA						
	Note on materials	RoHS-compliant						
	Dimensions	→ 41						
	Weight [g]	360						
AS-Interface data	Ident. code	ID = F _H ; ID1 = F _H ¹⁾ ; ID2 = E _H		ID = F _H ; ID1 = F _H ¹⁾ ; ID2 = E _H		ID = A _H ; ID1 = F _H ¹⁾ ; ID2 = E _H		
	IO code	7 _H		7 _H		7 _H		
	Profile	S-7.FE		S-7.FE		S-7.AE		
	Addressing range	1 ... 31		1 ... 31		1A ... 31A, 1B ... 31B		

1) Factory setting, is set by some programming devices (Spec. 2.1) when addressing slaves to 0_H

2) Matching cable distributor for flat cable to M12 → 42

Data sheet – Valve terminal MPA-S

Operating and environmental conditions	
Operating medium	Compressed air to ISO 8573-1:2010 [7:4:4]
Note on the operating/pilot medium	Lubricated operation possible (in which case lubricated operation will always be required)
Operating pressure [bar]	-0.9 ... +10
Ambient temperature [°C]	-5 ... +50
Temperature of medium [°C]	-5 ... +50
Storage temperature [°C]	-20 ... +40
Corrosion resistance class CRC ¹⁾	0
Relative humidity	Max. 90% at 40°C
CE marking (see declaration of conformity)	To EU EMC Directive ²⁾ To EU Explosion Protection Directive (ATEX)
KC mark	KC EMC
Certification	c UL us - Recognized (OL) RCM trademark
Degree of protection	IP67

1) Corrosion resistance class CRC 0 to Festo standard FN 940070

No corrosion stress. Applies to small, visually unimportant standards-based parts such as threaded pins, circlips and clamping sleeves which are usually only available on the market in a phosphated or burnished version (and possibly oiled) as well as to ball bearings (for components < CRC 3) and plain bearings.











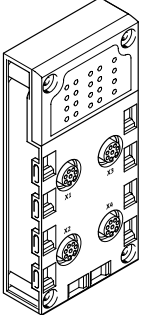
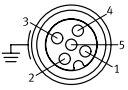
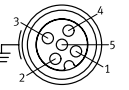
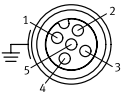
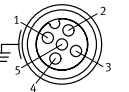
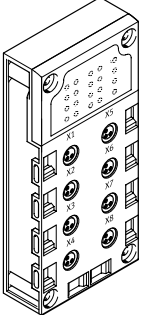

2) For information about the area of use, see the EC declaration of conformity at: www.festo.com/sp → Certificates.

If the devices are subject to usage restrictions in residential, commercial or light-industrial environments, further measures for the reduction of the emitted interference may be necessary.

ATEX	
Type	MPA-ASI-VI
ATEX category for gas	II 3 G
Type of ignition protection for gas	Ex nA IIC T4 X Gc
Explosion-proof ambient temperature [°C]	-5 ≤ Ta ≤ +50
CE marking (see declaration of conformity)	To EU Explosion Protection Directive (ATEX)

Data sheet – Valve terminal MPA-S

Combinations of connection blocks and electronics modules for inputs			
Connection blocks	Part no.	VMPA-...-8E8A	VMPA-...-4E4A
CPX-AB-4-M12X2-5POL	195704	■	■
CPX-AB-8-M8-3POL	195706	■	■
CPX-AB-8-KL-4POL	195708	■	■
CPX-AB-1-SUB-BU-25POL	525676	■	■
CPX-AB-4-HAR-4POL	525636	■	■

Pin allocation							
Connection block inputs		VMPA-...-8E8A	VMPA-...-4E4A				
CPX-AB-4-M12X2-5P							
	 X 1	 X 3	X1.1: 24 V _{SEN} X1.2: Input x+1 X1.3: 0 V _{SEN} X1.4: Input x X1.5: FE	X3.1: 24 V _{SEN} X3.2: Input x+5 X3.3: 0 V _{SEN} X3.4: Input x+4 X3.5: FE	X1.1: 24 V _{SEN} X1.2: Input x+1 X1.3: 0 V _{SEN} X1.4: Input x X1.5: FE	X3.1: 24 V _{SEN} X3.2: Input x+3 X3.3: 0 V _{SEN} X3.4: Input x+2 X3.5: FE	
	 X 2	 X 4	X2.1: 24 V _{SEN} X2.2: Input x+3 X2.3: 0 V _{SEN} X2.4: Input x+2 X2.5: FE	X4.1: 24 V _{SEN} X4.2: Input x+7 X4.3: 0 V _{SEN} X4.4: Input x+6 X4.5: FE	X2.1: 24 V _{SEN} X2.2: n.c. X2.3: 0 V _{SEN} X2.4: Input x+1 X2.5: FE	X4.1: 24 V _{SEN} X4.2: n.c. X4.3: 0 V _{SEN} X4.4: Input x+3 X4.5: FE	
CPX-AB-8-M8-3P							
	 X1	 X5	X1.1: 24 V _{SEN} X1.3: 0 V _{SEN} X1.4: Input x	X5.1: 24 V _{SEN} X5.3: 0 V _{SEN} X5.4: Input x+4	X1.1: 24 V _{SEN} X1.3: 0 V _{SEN} X1.4: Input x	X5.1: 24 V _{SEN} X5.3: 0 V _{SEN} X5.4: Input x+2	
	 X2	 X6	 X3	 X7	X2.1: 24 V _{SEN} X2.3: 0 V _{SEN} X2.4: Input x+1	X6.1: 24 V _{SEN} X6.3: 0 V _{SEN} X6.4: Input x+5	X2.1: 24 V _{SEN} X2.3: 0 V _{SEN} X2.4: Input x+1
 X3	 X7	 X4	 X8	X3.1: 24 V _{SEN} X3.3: 0 V _{SEN} X3.4: Input x+2	X7.1: 24 V _{SEN} X7.3: 0 V _{SEN} X7.4: Input x+6	X3.1: 24 V _{SEN} X3.3: 0 V _{SEN} X3.4: Input x+1	X7.1: 24 V _{SEN} X7.3: 0 V _{SEN} X7.4: Input x+3
 X4	 X8	X4.1: 24 V _{SEN} X4.3: 0 V _{SEN} X4.4: Input x+3	X8.1: 24 V _{SEN} X8.3: 0 V _{SEN} X8.4: Input x+7	X4.1: 24 V _{SEN} X4.3: 0 V _{SEN} X4.4: n.c.	X8.1: 24 V _{SEN} X8.3: 0 V _{SEN} X8.4: n.c.		

Data sheet – Valve terminal MPA-S

Pin allocation

Connection block inputs

VMPA-...-8E8A

VMPA-...-4E4A

CPX-AB-8-KL-4P

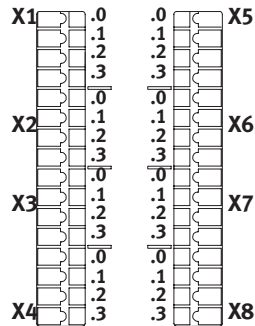
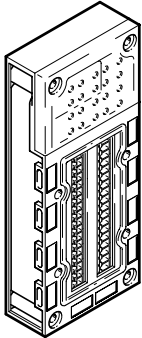

X1.0: 24 V _{SEN}	X5.0: 24 V _{SEN}	X1.0: 24 V _{SEN}	X5.0: 24 V _{SEN}
X1.1: 0 V _{SEN}	X5.1: 0 V _{SEN}	X1.1: 0 V _{SEN}	X5.1: 0 V _{SEN}
X1.2: Input x	X5.2: Input x+4	X1.2: Input x	X5.2: Input x+2
X1.3: FE	X5.3: FE	X1.3: FE	X5.3: FE
X2.0: 24 V _{SEN}	X6.0: 24 V _{SEN}	X2.0: 24 V _{SEN}	X6.0: 24 V _{SEN}
X2.1: 0 V _{SEN}	X6.1: 0 V _{SEN}	X2.1: 0 V _{SEN}	X6.1: 0 V _{SEN}
X2.2: Input x+1	X6.2: Input x+5	X2.2: Input x+1	X6.2: Input x+3
X2.3: FE	X6.3: FE	X2.3: FE	X6.3: FE
X3.0: 24 V _{SEN}	X7.0: 24 V _{SEN}	X3.0: 24 V _{SEN}	X7.0: 24 V _{SEN}
X3.1: 0 V _{SEN}	X7.1: 0 V _{SEN}	X3.1: 0 V _{SEN}	X7.1: 0 V _{SEN}
X3.2: Input x+2	X7.2: Input x+6	X3.2: Input x+1	X7.2: Input x+3
X3.3: FE	X7.3: FE	X3.3: FE	X7.3: FE
X4.0: 24 V _{SEN}	X8.0: 24 V _{SEN}	X4.0: 24 V _{SEN}	X8.0: 24 V _{SEN}
X4.1: 0 V _{SEN}	X8.1: 0 V _{SEN}	X4.1: 0 V _{SEN}	X8.1: 0 V _{SEN}
X4.2: Input x+3	X8.2: Input x+7	X4.2: n.c.	X8.2: n.c.
X4.3: FE	X8.3: FE	X4.3: FE	X8.3: FE

CPX-AB-1-SUB-BU-25P

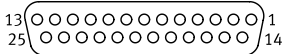
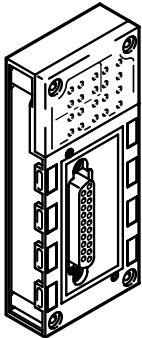

1: Input x	14: Input x+4	1: Input x	14: Input x+2
2: Input x+1	15: Input x+5	2: Input x+1	15: Input x+3
3: Input x+2	16: Input x+6	3: Input x+1	16: Input x+3
4: Input x+3	17: Input x+7	4: n.c.	17: n.c.
5: 24 V _{SEN}	18: 24 V _{SEN}	5: 24 V _{SEN}	18: 24 V _{SEN}
6: 0 V _{SEN}	19: 24 V _{SEN}	6: 0 V _{SEN}	19: 24 V _{SEN}
7: 24 V _{SEN}	20: 24 V _{SEN}	7: 24 V _{SEN}	20: 24 V _{SEN}
8: 0 V _{SEN}	21: 24 V _{SEN}	8: 0 V _{SEN}	21: 24 V _{SEN}
9: 24 V _{SEN}	22: 0 V _{SEN}	9: 24 V _{SEN}	22: 0 V _{SEN}
10: 24 V _{SEN}	23: 0 V _{SEN}	10: 24 V _{SEN}	23: 0 V _{SEN}
11: 0 V _{SEN}	24: 0 V _{SEN}	11: 0 V _{SEN}	24: 0 V _{SEN}
12: 0 V _{SEN}	25: FE	12: 0 V _{SEN}	25: FE
13: FE	Socket: FE	13: FE	Socket: FE

CPX-AB-4-HAR-4P

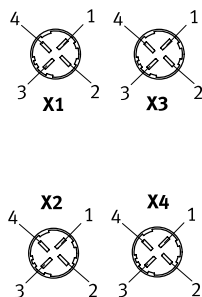
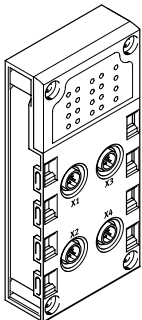

X1.1: 24 V _{SEN}	X3.1: 24 V _{SEN}	X1.1: 24 V _{SEN}	X3.1: 24 V _{SEN}
X1.2: Input x+1	X3.2: Input x+5	X1.2: Input x+1	X3.2: Input x+3
X1.3: 0 V _{SEN}	X3.3: 0 V _{SEN}	X1.3: 0 V _{SEN}	X3.3: 0 V _{SEN}
X1.4: Input x	X3.4: Input x+4	X1.4: Input x	X3.4: Input x+2
X2.1: 24 V _{SEN}	X4.1: 24 V _{SEN}	X2.1: 24 V _{SEN}	X4.1: 24 V _{SEN}
X2.2: Input x+3	X4.2: Input x+7	X2.2: n.c.	X4.2: n.c.
X2.3: 0 V _{SEN}	X4.3: 0 V _{SEN}	X2.3: 0 V _{SEN}	X4.3: 0 V _{SEN}
X2.4: Input x+2	X4.4: Input x+6	X2.4: Input x+1	X4.4: Input x+3

Data sheet – Valve terminal MPA-S

Dimensions

Download CAD data → www.festo.com

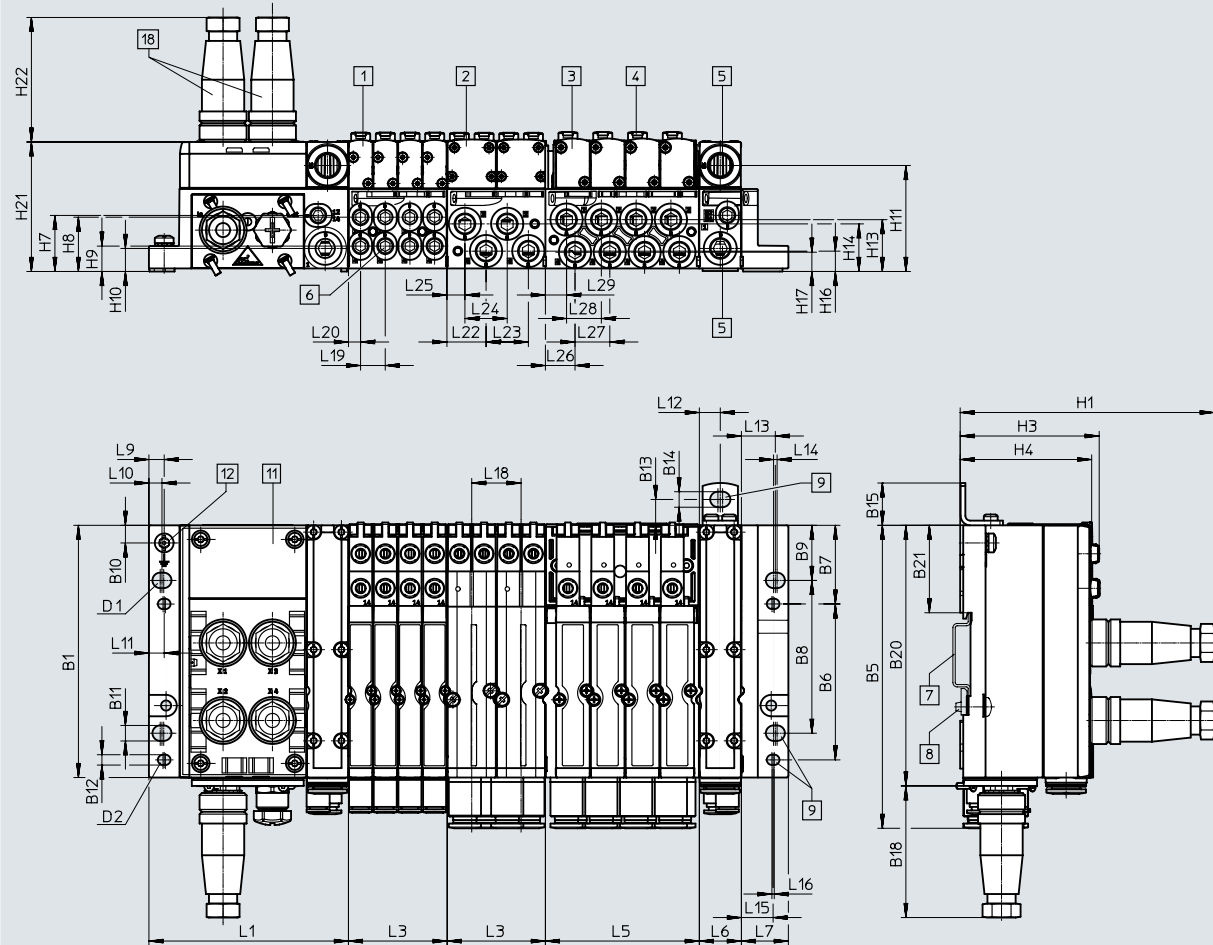

- [1] Solenoid valve MPA1
 - [2] Solenoid valve MPA2
 - [3] Solenoid valve MPA14
 - [4] Manual override
 - [5] Supply/exhaust ports
 - [6] Working ports
 - [7] H-rail
 - [8] H-rail mounting
 - [9] Mounting holes
 - [11] Connection block
 - [12] Earthing screw
 - [18] Plug M12
- n Number of sub-bases in a grid of 4 MPA1, 4 MPA14 or 2 MPA2 valves

Type	B1	B5	B6	B7	B8	B9	B10	B11	B12	B13	B14	B15	B18	B20	B21
MPA-S (AS-i)	107.3	128.9	66.3	33.5	65	23.5	7.5	6.6	4.4	11	6.6	18	56	110.9	37.2







Type	D1	D2	H1	H3	H4	H7	H8	H9	H11	H13	H14	H16	H17	H21	H22
MPA-S (AS-i)	M6	M4	108.1	59	56	23.9	23.1	10.8	45.1	22.1	20.3	8.7	8.2	55.1	53

Type	L1	L3 ¹⁾	L5 ¹⁾	L6	L7	L9	L10	L11	L12	L13	L14	L15
MPA-S (AS-i)	85	n x 42	n x 65.5	17.9	20	6.5	5.6	6.5	9	14.5	1.5	13.5

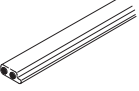

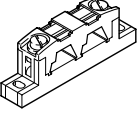
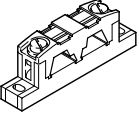

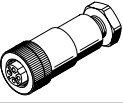
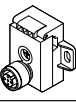
Type	L16	L18	L19	L20	L22	L23	L24	L25	L26	L27	L28	L29
MPA-S (AS-i)	1	21	10.5	5.2	16.7	18	18	7.7	12.6	14.8	14.8	9

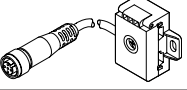
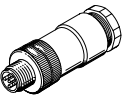
1) n = number of sub-bases (with MPA1, width 10 mm and MPA14, width 14 mm, max. 4 valve positions on sub-base; with MPA2, width 20 mm, max. 2 valve positions on sub-base)

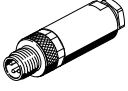
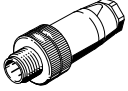

Data sheet – Valve terminal MPA-S

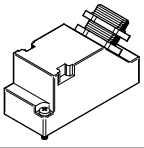
Ordering data		Designation	Part no.	Type
Bus connection				
	AS-Interface flat cable 100 mm	Yellow	18940	KASI-1.5-Y-100
		Black	18941	KASI-1.5-Z-100
	Flat cable dummy plug		196090	ASI-SD-FK-BL
	AS-Interface flat cable distributor	Rotatable cable	18786	ASI-KVT-FK
	AS-Interface flat cable distributor	Symmetrical cable	18797	ASI-KVT-FK-S
	Cable cap for flat cable (pack of 50)		18787	ASI-KK-FK
	Cable sleeve (pack of 20)		165593	ASI-KT-FK
	M12 socket, 4-pin	For AS-Interface flat cable	18789	ASI-SD-PG-M12
	M12 socket, 5-pin	For round cable	18324	FBSD-GD-9-5POL
Cable distributor				
	AS-Interface data to socket M12, 4-pin		572225	NEFU-X22F-M12G4
	AS-Interface data and load voltage supply to socket M12, 4-pin		572226	NEFU-X24F-M12G4
	AS-Interface data and load voltage supply to socket M12, 4-pin, cable length 1 m		572227	NEFU-X24F-1-M12G4
DUO plug				
	Plug M12 for 2 connecting cables	4-pin	18779	SEA-GS-11-DUO
		5-pin	192010	SEA-5GS-11-DUO

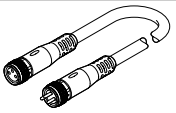
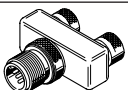
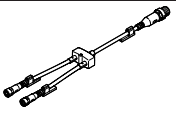
Data sheet – Valve terminal MPA-S

Ordering data		Designation	Part no.	Type
Sensor plug				
	Straight plug, M8, 3-pin	Screw-in	192009	SEA-3GS-M8-S
		Solderable	18696	SEA-GS-M8
	Straight plug, M12	4-pin, PG7	18666	SEA-GS-7
		4-pin, PG9	18778	SEA-GS-9
		4 pin, for 2.5 mm cable ø	192008	SEA-4GS-7-2.5
		5-pin, PG7	175487	SEA-M12-5GS-PG7
	Harax plug	4-pin	525928	SEA-GS-HAR-4POL
	Sub-D plug	25-pin	527522	SD-SUB-D-ST25
	Cover cap (pack of 10)	M8	177672	ISK-M8
		M12	165592	ISK-M12
Connecting cable				
	Modular system for a choice of connecting cables → Internet: nebu		–	NEBU-...
	Straight plug M8, 3-pin, straight socket M8, 3-pin	0.5 m	541346	NEBU-M8G3-K-0.5-M8G3
		1.0 m	541347	NEBU-M8G3-K-1-M8G3
		2.5 m	541348	NEBU-M8G3-K-2.5-M8G3
		5.0 m	541349	NEBU-M8G3-K-5-M8G3
Straight plug M12, 4-pin, straight socket M12, 5-pin	0.5 m	8000208	NEBU-M12G5-K-0.5-M12G4	
Push-in T-connector				
	Plug M12, A-coded, 4-pin	2x socket M12, A-coded, 5-pin	8005310	NEDY-L2R1-V1-M12G5-N-M12G4
		2x socket M8, A-coded, 3-pin	8005311	NEDY-L2R1-V1-M8G3-N-M12G4
	Modular system for all types of sensor/actuator distributor → Internet: nedy		–	NEDY-...

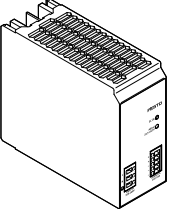
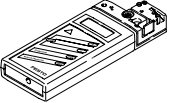
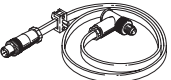
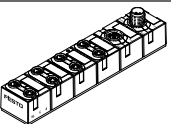
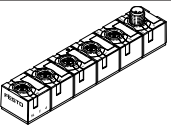
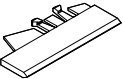
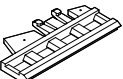
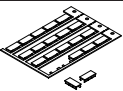
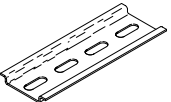
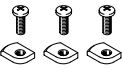
Data sheet – Valve terminal MPA-S

Ordering data		Designation	Part no.	Type
Other				
	Primary switched-mode, modular power supply 24 V DC power supply	5 A	2247681	CACN-3A-1-5
		10 A	2247682	CACN-3A-1-10
	Addressing device (power supply plug included in the scope of delivery)		18959	ASI-PRG-ADR
	Addressing cable		18960	KASI-ADR
	AS-Interface input module for 8 inputs M8, compact		542124	ASI-8DI-M8-3POL
	AS-Interface input/output module for 4 inputs/3 outputs M12, compact		542125	ASI-4DI3DO-M12X2-5POL-Z
	For foil Inscription label holder for sub-base, transparent, for paper foil label	Can be used for VMPA1 VMPA2	533362	VMPA1-ST-1-4
		Can be used for VMPA14	8085996	VMPA14-ST-1-4
	For IBS Inscription label holder for sub-base, 4-part, for IBS 6x10	Can be used for VMPA1 VMPA2	544384	VMPA1-ST-2-4
		Can be used for VMPA14	8085997	VMPA14-ST-2-4
	Inscription labels 6x10 mm in frames (pack of 64)		18576	IBS 6x10
	H-rail to EN 60715		35430	NRH-35-2000
	H-rail mounting		526032	CPX-CPA-BG-NRH
	Mounting bracket		534416	VMPA-BG-RW
User documentation				
	Manual for MPA-S pneumatics	German	534240	P.BE-MPA-DE
		English	534241	P.BE-MPA-EN
		French	534243	P.BE-MPA-FR
		Italian	534244	P.BE-MPA-IT
		Spanish	534242	P.BE-MPA-ES

VTSA/VTSA-F valve terminal

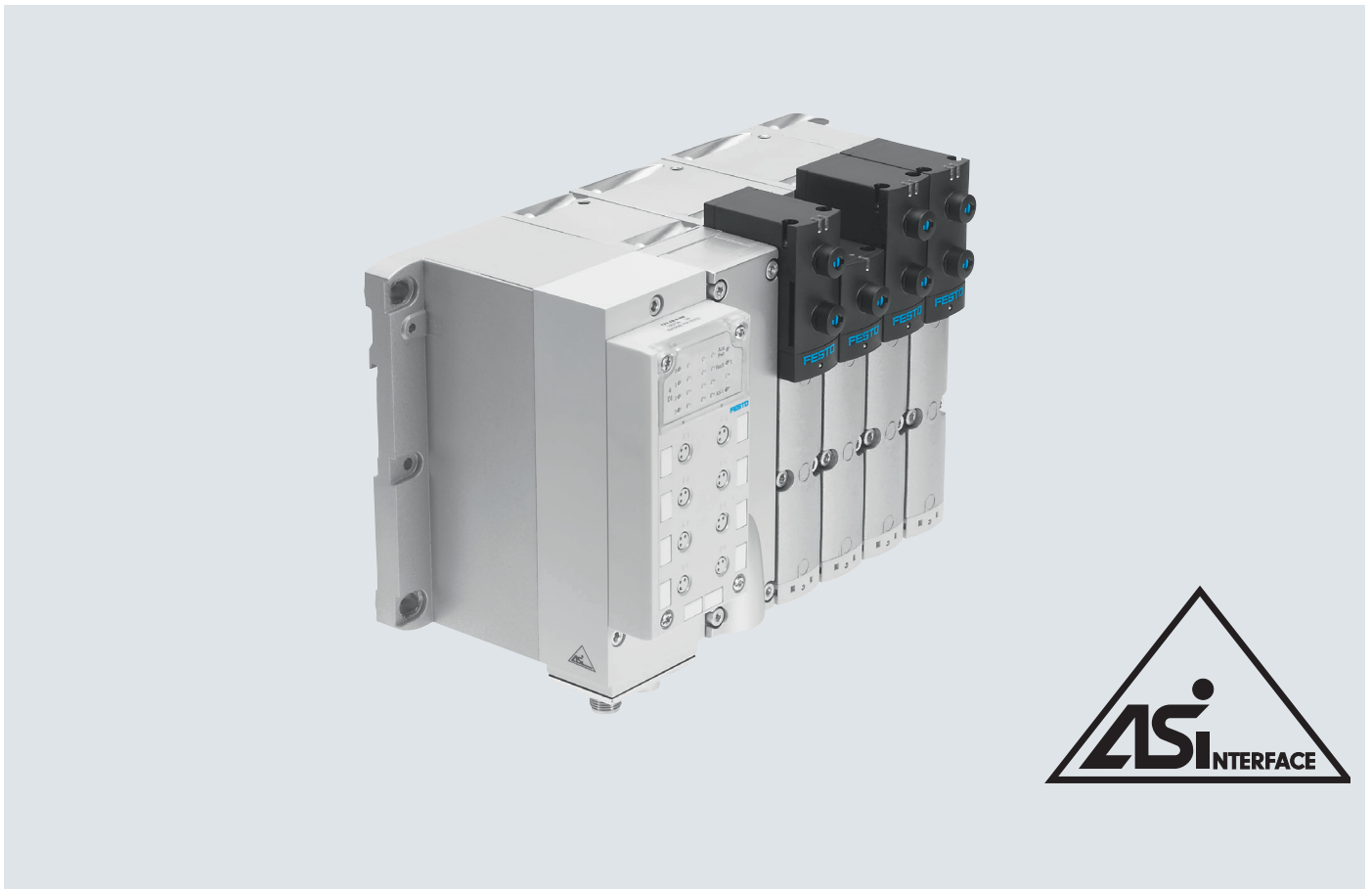

VTSA/VTSA-F valve terminals with AS-Interface – Valve configuration options

VTSA/VTSA-F valve terminals with AS-Interface can be flexibly configured with a wide range of valves. The system supports a maximum of 8 outputs (solenoid coils) and 8 inputs per valve terminal. This gives the following basic valve configuration options (see tables on following page)

**Note**

Please follow the link below for more details on the various pneumatic functions.

- Internet: [vtsa](#)
- Internet: [vtsa-f](#)

General

- Solutions with integrated inputs
- Width 18, 26, 42 and 52 mm
- With or without 24 V DC auxiliary power supply for solenoid coils (EMERGENCY-STOP circuitry) with version 4I/4O. The auxiliary power supply is always integrated in the version with 8 inputs and cannot be subsequently switched off using the DIL switch.
- Selectable bus connection technology
 - Flat cable for AS-Interface with 4I/4O version
 - 4-pin M12 round plug¹⁾ with 4I/4O and 8I/8O version
- Selectable addressing
 - Via bus connection (M12 or flat cable)

Versions

- 1 to 8 valves, freely configurable
- Soft-start valve for slow and safe pressure build-up
 - High degree of safety
 - Safe pressurisation with sensor function
- With 4 or 8 inputs
- M8, M12, quick connection, spring-loaded terminal or Sub-D connection technology
- Separating seals for creating pressure zones
- Suitable for vacuum
- Subsequent extensions either
 - via vacant positions
 - by converting the valve terminal

Application

- Flexible and cost-effective connection of 1 or 8 valves (max. 8 solenoid coils) with input feedback.
- Decentralised machine and system structures, e.g.
 - in handling technology
 - in conveyor technology
 - in the packaging industry
 - in sorting systems
 - suitable for energy chains thanks to connection via round cables

1) Matching cable distributor for flat cable to M12 → 54

VTSA/VTSA-F valve terminal – Connection technology and addressing

Types of valve terminal with AS-Interface									
Type	Valves	Solenoid coils	Inputs	Auxiliary power supply can be switched off		Width (mm)			
				Yes	No	18	26	42 ¹⁾	52 ¹⁾
VTSA/VTSA-F-ASI-4E4A-Z	4	4	4	■	–	■	■	■	■
VTSA/VTSA-F-ASI-8E8A-Z	8	8	8	–	■	■	■	■	■

1) Width 42 and 52 mm not with VTSA-F – with width 52 mm, the auxiliary power supply is required.

Permissible combinations in valve position allocation (examples)				
Type	Slave n			
	0	1	2	3
4l/40 VTSA/VTSA-F - 18 and 26 mm (2 valves per sub-base)	M	M	M	M
	M	M	M	L
	M	M	–	–
	M	L	–	–

	J	M	–	–
	M	J	–	–
	J	J	–	–
Special case	M	M	J	L
4l/40 VTSA – 42 and 52 mm (1 valve per sub-base)	M	M	M	M
	M	M	M	L
	M	M	–	–
	M	–	–	–

	J	M	–	–
	J	M	M	–

	M	J	M	–
	J	J	–	–

Permissible combinations in valve position allocation (examples)								
Type	Slave n plus slave n+1							
	0	1	2	3	4	5	6	7
8l/80 VTSA/VTSA-F	M	M	M	M	M	M	M	M
	M	M	M	L	M	M	M	L

	J	J	J	J	–	–	–	–
	J	J	J	M	–	–	–	–
	J	J	M	M	–	–	–	–

	J	J	M	M	M	M	–	–

- 1) All valve slices are freely configurable, limited by the number of solenoid coils supported (4 or 8).
 A cover plate can be used instead of a valve slice, a cover plate can be used as reserve position for one or two solenoid coils.
- M Valve slice with single solenoid valve or alternatively a different valve slice with one output
 J Valve slice with double solenoid valve or alternatively a different valve slice with two outputs
 L Vacant position

VTSA/VTSA-F valve terminal – Connection technology and addressing

Installation: Selectable connection technology for AS-Interface

Support for flat cables

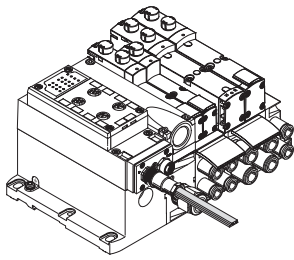

- Straightforward installation with flat cable in the more protected area
- Fast installation technology with standard AS-Interface cables
- Standard installation at the AS-Interface using yellow flat cable possible with VTSA/VTSA-F version 4I/4O

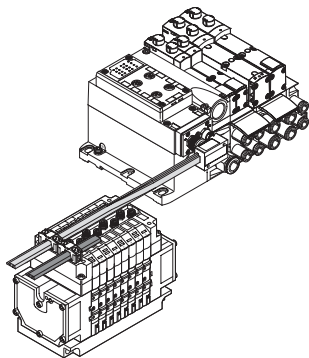

Support for round cables

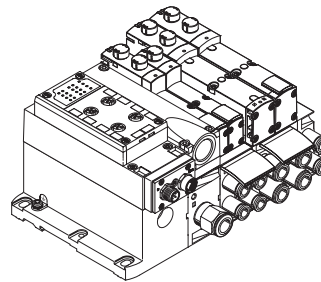

Local round cable wiring for areas with permanently higher loads:

- Consistently high humidity
- Need for flexible installation with one cable
- Use in energy chains with highly flexible lines

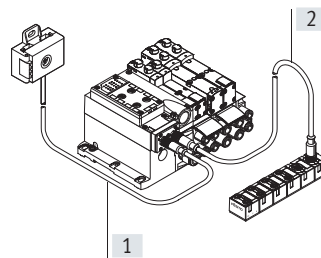

- [1] Pre-assembled M12 round cable, 1 m, polyurethane
- [2] Optional cable for additional slave, e.g. highly flexible cable for energy chains or PVC cable for applications requiring resistance to cleaning agents

Addressing

Addressing device

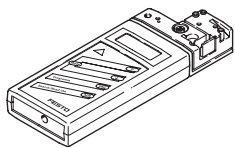

Using the addressing device according to SPEC V2.1, it is possible to scan the AS-Interface from any chosen point in the network. At all connected stations:

- Slave addresses can be read/changed
- ID and IO codes can be read out
- Parameters can be read/changed
- Input/output data can be read and written (setting outputs)
- Error messages can be read out and quickly recognised.

AS-Interface connections

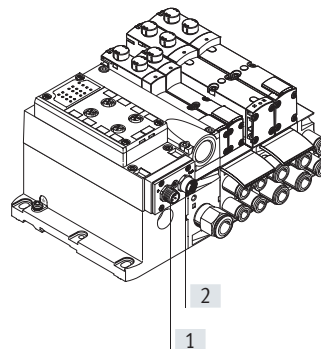

- [1] M12 plug for AS-Interface and incoming auxiliary supply
- [2] M12 socket for AS-Interface and outgoing auxiliary supply

VTSA/VTSA-F valve terminal – Connection technology and addressing

AS-Interface flat cable distributor to round cable

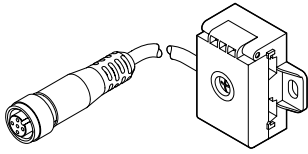

Alternative connection concepts

- Connection technology for AS-Interface for yellow and optionally for black flat cable
- Passive conversion of signals on M12 socket and round cable with M12 socket
- Pre-assembled round cable 1 m, PUR
- Optional PVC extension cable, or other suitable cable of any length, via additional M12 socket

Selecting the cable

It is easy to implement optimised connection technologies at the AS-Interface by choosing the appropriate cable:

- Flat cables for all standard applications with insulation displacement technology to reduce installation effort
- Round cables for applications with different requirements, e.g.:
 - Energy chains with a small radius and increased requirement for highly flexible cables
 - Applications with consistently high humidity

- Applications in which a lot of cleaning takes place and in which cables that are resistant to cleaning agents are required (PUR, PVC or other cables)
- Cabling with standards (M12) preferred

Easy to assemble

Direct assembly on the wall or machine frame.

Supplementary, compact I/O modules

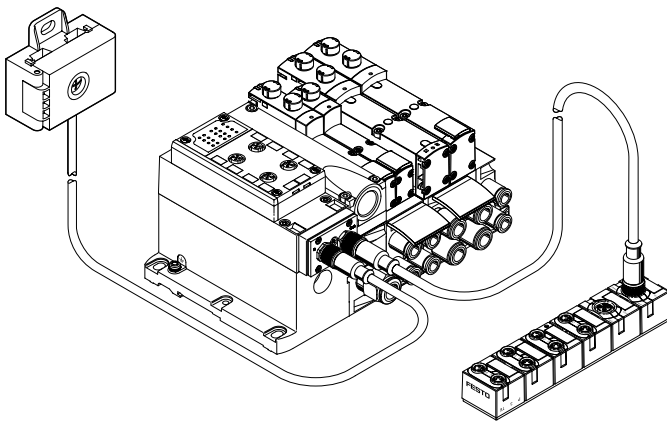

The compact I/O modules can be used to supplement the valve terminals VTSA/VTSA-F. The following are available:

- 8 inputs M8
- 4 inputs/3 outputs M12

Key features – Display and operation

Display and operation

Each solenoid coil is allocated an LED which indicates its switching status.

- Indicator 12 shows the switching status of the pilot control for output 2
- Indicator 14 shows the switching status of the pilot control for output 4

Manual override

The manual override enables the valve to be switched when not electrically actuated or energised.

The valve is switched by pushing the manual override. The set switching status can also be locked by rotating the manual override.

Alternatives:

- A cover cap (accessory code N) can be fitted over the manual override to prevent it from being rotated. The valve can then only be actuated by pressing it.

- A cover cap (code V) can be fitted over the manual override to prevent it from being accidentally actuated.

Pneumatic connection and control elements

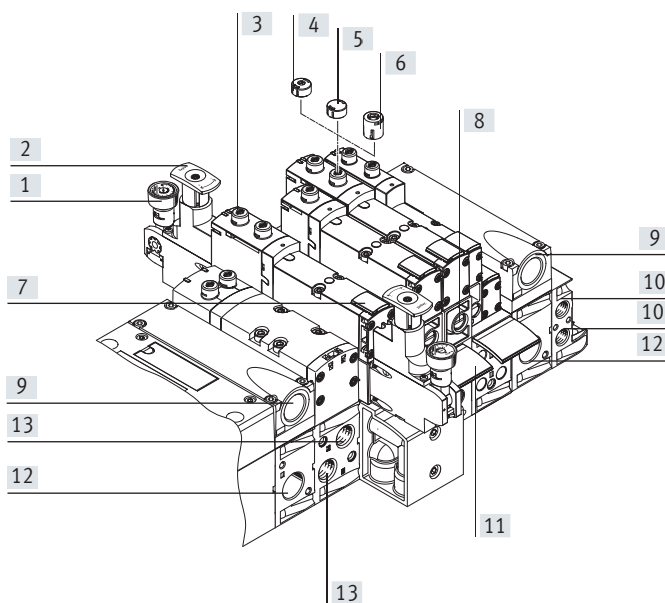

- [1] Pressure gauge (optional)
- [2] Adjusting knob for optional pressure regulator plate
- [3] Manual override (for each pilot solenoid coil, non-detenting or non-detenting/detenting)
- [4] Cover cap for manual override, non-detenting
- [5] Cover cap for manual override, concealed
- [6] Heavy-duty cover cap for manual override, non-detenting heavy duty, detenting via accessory
- [7] Inscription label holder for valve
- [8] Adjusting screw of optional throttle plate
- [9] Exhaust ports "Valves" (3/5)
- [10] Pilot ports 12 and 14 for supplying the external pilot air
- [11] Inscription label holder for sub-base
- [12] Supply port 1 (operating pressure)
- [13] Working ports 2 and 4, per valve position

 **Note**

A manually operated valve (manual override) cannot be reset electrically. Conversely, an electrically actuated valve cannot be reset using the mechanical manual override.

Electrical connection and display elements

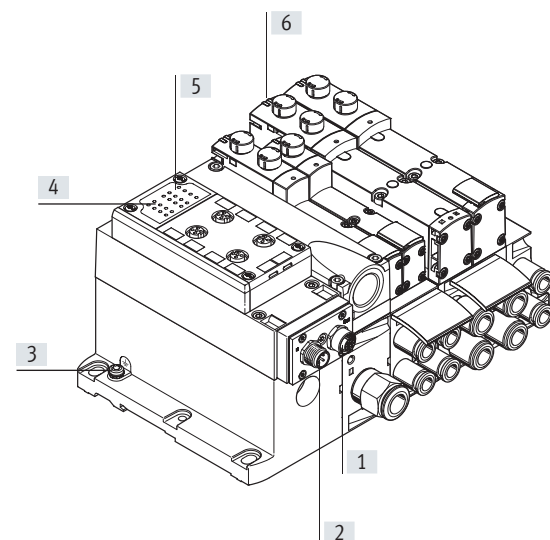

- [1] M12 socket, AS-Interface bus and auxiliary power supply (AS-i Out)
- [2] M12 plug for AS-Interface bus and auxiliary power supply (AS-i In)
- [3] Earth terminal
- [4] Status LEDs for inputs
- [5] Status LEDs for AS-Interface
- [6] Diagnostic LEDs for valves

Data sheet – Valve terminal VTSA/VTSA-F

General technical data		VTSA/VTSA-F-ASI-4E4A-Z		VTSA/VTSA-F-ASI-8E8A-Z	
Type					
Part no.		Order via ident. code/valve terminal configurator			
Mounting position		Any			
Digital inputs	Number of inputs	4		8	
	Connection technology	M12 5-pin, M8 3-pin, quick connection, spring-loaded terminal, Sub-D			
	Sensor supply via AS-Interface	Short-circuit and overload protected			
	Sensor connection	2-wire and 3-wire sensors			
	Design	IEC 1131-2, type 02			
	Input circuit	PNP (positive switching)			
Valves	Number of solenoid coils	4		8	
	Valve width [mm]	18/26/42/52 (width 42 and 52 mm only with VTSA)			
	Power supply (auxiliary supply) 24 V DC	Set using DIL switch		Yes	
Max. current consumption of valves per solenoid coil [mA]		90			
AS-Interface connection	Connection technology	Plug M12x1, 4-pin; socket M12x1, 4-pin ²⁾			
	Voltage range [V DC]	26.5 ... 31.6, reverse polarity protected			
	Residual ripple [mVss]	20			
	Electrical isolation of the fieldbus interface	Optocoupler			
	Current consumption, inputs [mA]	Without auxiliary power supply	With auxiliary power supply	With auxiliary power supply	
	Basic electronic load	≤25	≤25	≤25	
	Total input current	350	350	350	
	Total current consumption	Max. 500	Max. 700	Max. 700	
Load voltage connection	Connection technology	M12 connection ²⁾			
	Voltage range [V DC]	21.6 ... 26.4			
	Residual ripple [Vss]	4			
LED displays	ASI LED	Green			
	AUX-PWR LED	Green			
	FAULT LED	Red			
	Inputs	Green			
	Valves	Yellow			
AS-Interface data	AS-Interface specification	AS-Interface complete Spec 3.0			
	Addressing range, slave	1 ... 31			
	Ident. code	ID = F _H ; ID1 = F _H ¹⁾ ; ID2 = E _H			
	IO code	7 _H			
Profile	S-7.FE				

1) Factory setting, is set by some programming devices (Spec. 2.1) when addressing slaves to 0_H

2) Matching cable distributor for flat cable to M12 → 54

Operating and environmental conditions

Degree of protection (to EN 60529)		IP65, NEMA 4 (in assembled state)	
Electromagnetic compatibility		Tested to EN 50295	
CE marking (see declaration of conformity)		To EU EMC Directive ¹⁾	
		To EU Low Voltage Directive	
Certification		c UL us - Recognized (OL)	
		C-Tick	
Ambient temperature [°C]		-5 ... +50	
Storage temperature [°C]		-20 ... +40	
Materials	Housing	Die-cast aluminium, PA	
	Seals	NBR, PUR	
Note on materials		RoHS-compliant	
Weight	AS-Interface connection [g]	300	
	Multi-pin node [g]	850	

1) For information about the area of use, see the EC declaration of conformity at: www.festo.com/sp → Certificates.

If the devices are subject to usage restrictions in residential, commercial or light-industrial environments, further measures for the reduction of the emitted interference may be necessary.

Data sheet – Valve terminal VTSA/VTSA-F

- Note







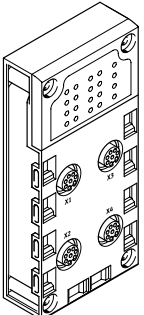
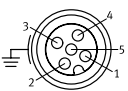
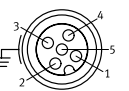
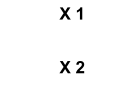
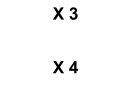
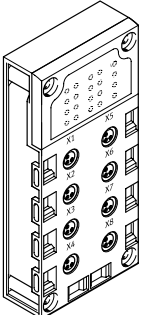

The valve terminal with AS-Interface connection is based on the same electrical links as the valve terminal with multi-pin plug connection.

This means it is possible to convert a valve terminal with multi-pin plug connection using an AS-Interface module. The technical specifications of the AS-Interface system must be observed in this case.



Combinations of connection blocks and electronics modules for inputs

Connection blocks	Part no.	VTSA/VTSA-F-ASI-8E8A-Z	VTSA/VTSA-F-ASI-4E4A-Z
CPX-AB-4-M12x2-5POL	195704	■	■
CPX-AB-4-M12x2-5POL-R	541254	■	■
CPX-AB-8-KL-4POL	195708	■	■
CPX-AB-1-Sub-BU-25POL	525676	■	■
CPX-AB-4-HAR-4POL	525636	■	■
CPX-AB-8-M8-3POL	195706	■	■

Pin allocation

Connection block inputs		VTSA/VTSA-F-ASI-8E8A-Z	VTSA/VTSA-F-ASI-4E4A-Z
CPX-AB-4-M12X2-5POL			
	 X 1	 X 3	X1.1: 24 V _{SEN} X1.2: Input x+1 X1.3: 0 V _{SEN} X1.4: Input x X1.5: FE
	 X 2	 X 4	X3.1: 24 V _{SEN} X3.2: Input x+5 X3.3: 0 V _{SEN} X3.4: Input x+4 X3.5: FE
			X1.1: 24 V _{SEN} X1.2: Input x+1 X1.3: 0 V _{SEN} X1.4: Input x X1.5: FE
			X3.1: 24 V _{SEN} X3.2: Input x+3 X3.3: 0 V _{SEN} X3.4: Input x+2 X3.5: FE
			X2.1: 24 V _{SEN} X2.2: Input x+3 X2.3: 0 V _{SEN} X2.4: Input x+2 X2.5: FE
			X4.1: 24 V _{SEN} X4.2: Input x+7 X4.3: 0 V _{SEN} X4.4: Input x+6 X4.5: FE
			X2.1: 24 V _{SEN} X2.2: n.c. X2.3: 0 V _{SEN} X2.4: Input x+1 X2.5: FE
			X4.1: 24 V _{SEN} X4.2: n.c. X4.3: 0 V _{SEN} X4.4: Input x+3 X4.5: FE
CPX-AB-8-M8-3POL			
	 X1	 X5	X1.1: 24 V _{SEN} X1.3: 0 V _{SEN} X1.4: Input x
	 X2	 X6	X5.1: 24 V _{SEN} X5.3: 0 V _{SEN} X5.4: Input x+4
	 X3	 X7	X1.1: 24 V _{SEN} X1.3: 0 V _{SEN} X1.4: Input x
	 X4	 X8	X5.1: 24 V _{SEN} X5.3: 0 V _{SEN} X5.4: Input x+2
			X2.1: 24 V _{SEN} X2.3: 0 V _{SEN} X2.4: Input x+1
			X6.1: 24 V _{SEN} X6.3: 0 V _{SEN} X6.4: Input x+5
			X2.1: 24 V _{SEN} X2.3: 0 V _{SEN} X2.4: Input x+1
			X6.1: 24 V _{SEN} X6.3: 0 V _{SEN} X6.4: Input x+3
			X3.1: 24 V _{SEN} X3.3: 0 V _{SEN} X3.4: Input x+2
			X7.1: 24 V _{SEN} X7.3: 0 V _{SEN} X7.4: Input x+6
			X3.1: 24 V _{SEN} X3.3: 0 V _{SEN} X3.4: Input x+1
			X7.1: 24 V _{SEN} X7.3: 0 V _{SEN} X7.4: Input x+3
			X4.1: 24 V _{SEN} X4.3: 0 V _{SEN} X4.4: Input x+3
			X8.1: 24 V _{SEN} X8.3: 0 V _{SEN} X8.4: Input x+7
			X4.1: 24 V _{SEN} X4.3: 0 V _{SEN} X4.4: n.c.
			X8.1: 24 V _{SEN} X8.3: 0 V _{SEN} X8.4: n.c.

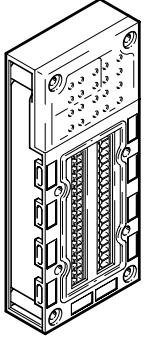
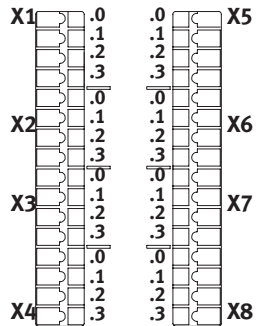
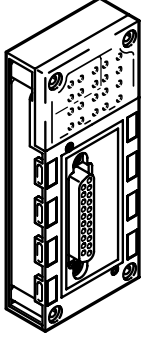
Data sheet – Valve terminal VTSA/VTSA-F

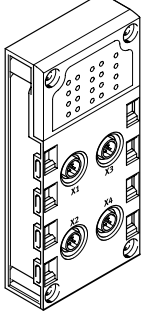
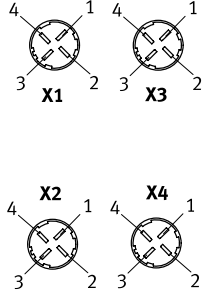
Pin allocation		VTSA/VTSA-F-ASI-8E8A-Z	VTSA/VTSA-F-ASI-4E4A-Z
Connection block inputs			
CPX-AB-8-KL-4POL			
		X1.0: 24 V _{SEN} X1.1: 0 V _{SEN} X1.2: Input x X1.3: FE X2.0: 24 V _{SEN} X2.1: 0 V _{SEN} X2.2: Input x+1 X2.3: FE X3.0: 24 V _{SEN} X3.1: 0 V _{SEN} X3.2: Input x+2 X3.3: FE X4.0: 24 V _{SEN} X4.1: 0 V _{SEN} X4.2: Input x+3 X4.3: FE	X5.0: 24 V _{SEN} X5.1: 0 V _{SEN} X5.2: Input x+4 X5.3: FE X6.0: 24 V _{SEN} X6.1: 0 V _{SEN} X6.2: Input x+5 X6.3: FE X7.0: 24 V _{SEN} X7.1: 0 V _{SEN} X7.2: Input x+6 X7.3: FE X8.0: 24 V _{SEN} X8.1: 0 V _{SEN} X8.2: Input x+7 X8.3: FE
CPX-AB-1-SUB-BU-25POL			
		1: Input x 2: Input x+1 3: Input x+2 4: Input x+3 5: 24 V _{SEN} 6: 0 V _{SEN} 7: 24 V _{SEN} 8: 0 V _{SEN} 9: 24 V _{SEN} 10: 24 V _{SEN} 11: 0 V _{SEN} 12: 0 V _{SEN} 13: FE	14: Input x+4 15: Input x+5 16: Input x+6 17: Input x+7 18: 24 V _{SEN} 19: 24 V _{SEN} 20: 24 V _{SEN} 21: 24 V _{SEN} 22: 0 V _{SEN} 23: 0 V _{SEN} 24: 0 V _{SEN} 25: FE Socket: FE
CPX-AB-4-HAR-4POL			
		X1.1: 24 V _{SEN} X1.2: Input x+1 X1.3: 0 V _{SEN} X1.4: Input x X2.1: 24 V _{SEN} X2.2: Input x+3 X2.3: 0 V _{SEN} X2.4: Input x+2	X3.1: 24 V _{SEN} X3.2: Input x+5 X3.3: 0 V _{SEN} X3.4: Input x+4 X4.1: 24 V _{SEN} X4.2: Input x+7 X4.3: 0 V _{SEN} X4.4: Input x+6

Data sheet – Valve terminal VTSA/VTSA-F

Dimensions

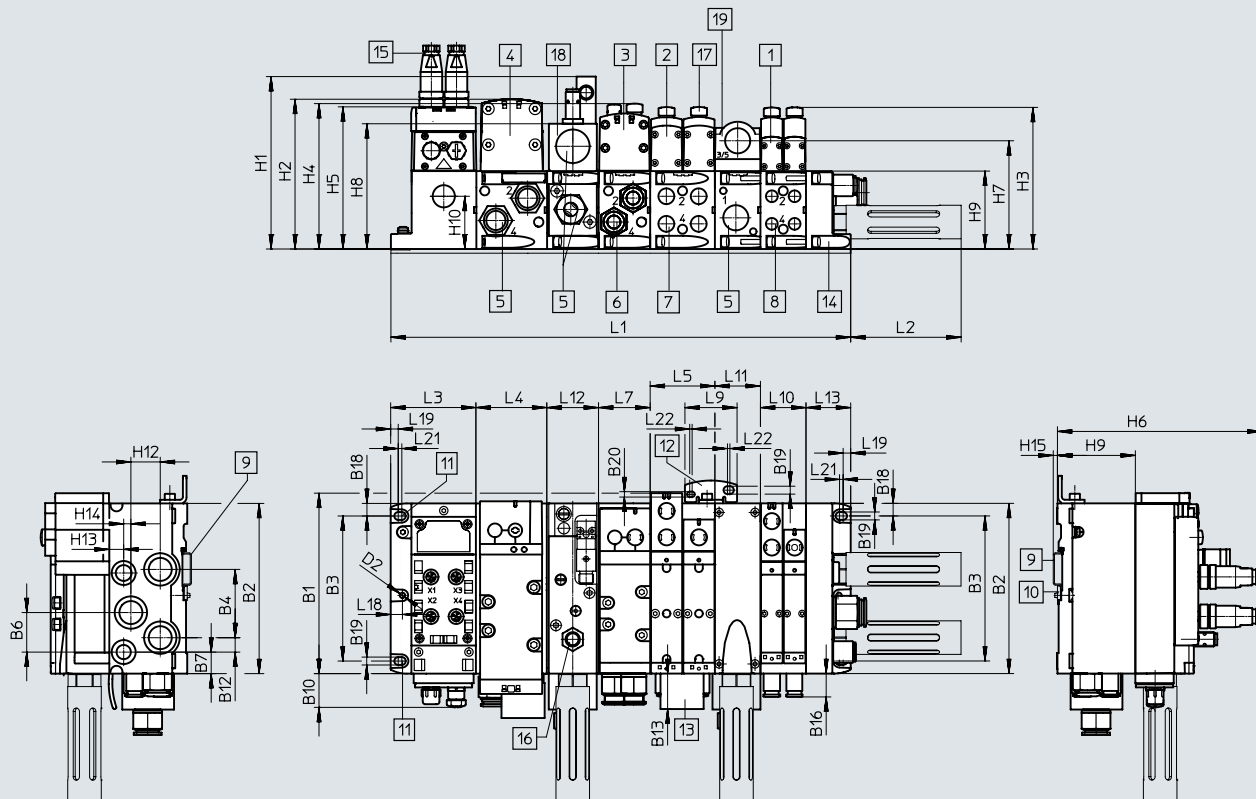
Download CAD data → www.festo.com

- | | | | | |
|-----------------------------------|----------------------------------|--------------------------------------|-----|------------------------------------|
| [1] Solenoid valve
Width 18 mm | [7] Threaded connection G1/4 | [16] Proximity switch M12x1 | n02 | Number of manifold sub-bases 38 mm |
| [2] Solenoid valve
Width 26 mm | [8] Threaded connection G1/8 | [17] Cover cap/manual override | n01 | Number of manifold sub-bases 54 mm |
| [3] Solenoid valve
Width 42 mm | [9] H-rail | [18] Soft start valve
Width 43 mm | n1 | Number of manifold sub-bases 43 mm |
| [4] Solenoid valve
Width 52 mm | [10] H-rail mounting | [19] Supply plate | n2 | Number of manifold sub-bases 59 mm |
| [5] Threaded connection G1/2 | [11] Mounting hole | | n | Number of supply plates |
| [6] Threaded connection G3/8 | [12] Additional mounting bracket | | | |
| | [13] Inscription label | | | |
| | [14] End plate | | | |
| | [15] Plug M12 | | | |







Dim.	B1	B2	B3	B4	B6	B7	B10	B12	B13	B14	B16	B18	B19	B20
[mm]	150.5	142	121	57	33	18	28	12	29.6	23	19.5	10.5	6.6	4.5

Dim.	L2	L3	L4	L5	L7	L9	L10	L11	L12	L13	L16	L18	L19	L20	L21
[mm]	92.4	71.3	n2x59	n01x54	n1x43	43.5	n02x38	nx38	43	37.3	20	9.8	6.3	5.5	3

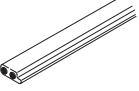

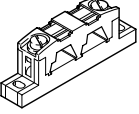
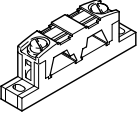

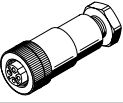
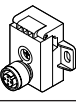
Dim.	L22	D2ø	H1	H2	H3	H4	H5	H6	H7	H8	H9	H10	H12	H13	H14	H15
[mm]	2	4.5	143.9	125	118.2	121.3	118.6	171	90.3	104.5	65	44	24.5	12	6	3.5

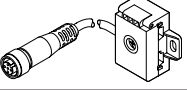
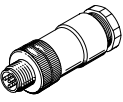
Width	L1
18 mm	$71.3 + n02 \times 38 + n \times 38 + 37.3$
26 mm	$71.3 + n01 \times 54 + n \times 38 + 37.3$
42 mm	$71.3 + n1 \times 43 + n \times 38 + 37.3$
52 mm	$71.3 + n2 \times 59 + n \times 38 + 37.3$
Mixture of 18 mm, 26 mm, 42 mm and 52 mm	$71.3 + n02 \times 38 + n01 \times 54 + n1 \times 43 + n2 \times 59 + n \times 38 + 37.3$



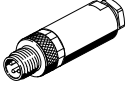
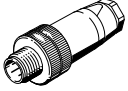

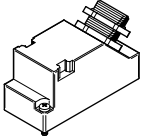
Data sheet – Valve terminal VTSA/VTSA-F

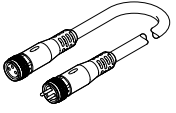
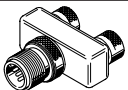
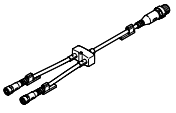
Ordering data		Designation	Part no.	Type
Bus connection				
	AS-Interface flat cable 100 mm	Yellow	18940	KASI-1.5-Y-100
		Black	18941	KASI-1.5-Z-100
	Flat cable dummy plug		196090	ASI-SD-FK-BL
	AS-Interface flat cable distributor	Rotatable cable	18786	ASI-KVF-FK
	AS-Interface flat cable distributor	Symmetrical cable	18797	ASI-KVF-FK-S
	Cable cap for flat cable (pack of 50)		18787	ASI-KK-FK
	Cable sleeve (pack of 20)		165593	ASI-KT-FK
	M12 socket, 4-pin	For AS-Interface flat cable	18789	ASI-SD-PG-M12
	M12 socket, 5-pin	For round cable	18324	FBSD-GD-9-5POL
Cable distributor				
	AS-Interface data to socket M12, 4-pin		572225	NEFU-X22F-M12G4
	AS-Interface data and load voltage supply to socket M12, 4-pin		572226	NEFU-X24F-M12G4
	AS-Interface data and load voltage supply to socket M12, 4-pin, cable length 1 m		572227	NEFU-X24F-1-M12G4
DUO plug				
	Plug M12 for 2 connecting cables	4-pin	18779	SEA-GS-11-DUO
		5-pin	192010	SEA-5GS-11-DUO

Data sheet – Valve terminal VTSA/VTSA-F

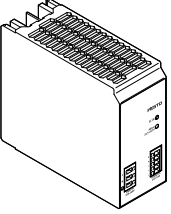
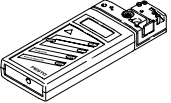
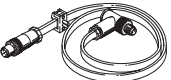
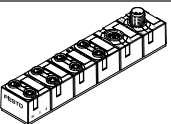
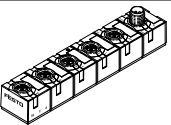
Ordering data		Designation	Part no.	Type
Sensor plug				
	Straight plug, M8, 3-pin	Screw-in	192009	SEA-3GS-M8-S
		Solderable	18696	SEA-GS-M8
	Straight plug, M12	4-pin, PG7	18666	SEA-GS-7
		4-pin, PG9	18778	SEA-GS-9
		4 pin, for 2.5 mm cable ø	192008	SEA-4GS-7-2.5
		5-pin, PG7	175487	SEA-M12-5GS-PG7
	Harax plug	4-pin	525928	SEA-GS-HAR-4POL
	Sub-D plug	25-pin	527522	SD-SUB-D-ST25
	Cover cap (pack of 10)	M8	177672	ISK-M8
		M12	165592	ISK-M12
Connecting cable				
	Modular system for a choice of connecting cables → Internet: nebu		–	NEBU-...
	Straight plug M8, 3-pin, straight socket M8, 3-pin	0.5 m	541346	NEBU-M8G3-K-0.5-M8G3
		1.0 m	541347	NEBU-M8G3-K-1-M8G3
		2.5 m	541348	NEBU-M8G3-K-2.5-M8G3
		5.0 m	541349	NEBU-M8G3-K-5-M8G3
Straight plug M12, 4-pin, straight socket M12, 5-pin	0.5 m	8000208	NEBU-M12G5-K-0.5-M12G4	
Push-in T-connector				
	Plug M12, A-coded, 4-pin	2x socket M12, A-coded, 5-pin	8005310	NEDY-L2R1-V1-M12G5-N-M12G4
		2x socket M8, A-coded, 3-pin	8005311	NEDY-L2R1-V1-M8G3-N-M12G4
	Modular system for all types of sensor/actuator distributor → Internet: nedy		–	NEDY-...

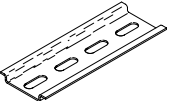
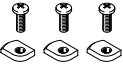
Data sheet – Valve terminal VTSA/VTSA-F

Ordering data		Designation	Part no.	Type
Other				
	Primary switched-mode, modular power supply 24 V DC power supply	5 A	2247681	CACN-3A-1-5
		10 A	2247682	CACN-3A-1-10
	Addressing device (power supply plug included in the scope of delivery)		18959	ASI-PRG-ADR
	Addressing cable		18960	KASI-ADR
	AS-Interface input module for 8 inputs M8		542124	ASI-8DI-M8-3POL
	AS-Interface input/output module for 4 inputs/3 outputs M12		542125	ASI-4DI3DO-M12X2-5POL-Z
	Clip-on inscription label holder for valve cap (pack of 5)		540888	ASCF-T-S6
	Inscription label holder for manifold blocks (pack of 5)		540889	ASCF-M-S6
	H-rail to EN 60715		35430	NRH-35-2000
	H-rail mounting		526032	CPX-CPA-BG-NRH
User documentation				
	Manual – Valve terminal VTSA and VTSA-F	German	538922	P.BE-VTSA-44-DE
		English	538923	P.BE-VTSA-44-EN
		French	538925	P.BE-VTSA-44-FR
		Italian	538926	P.BE-VTSA-44-IT
		Spanish	538924	P.BE-VTSA-44-ES

Compact I/O modules to Spec. 2.1

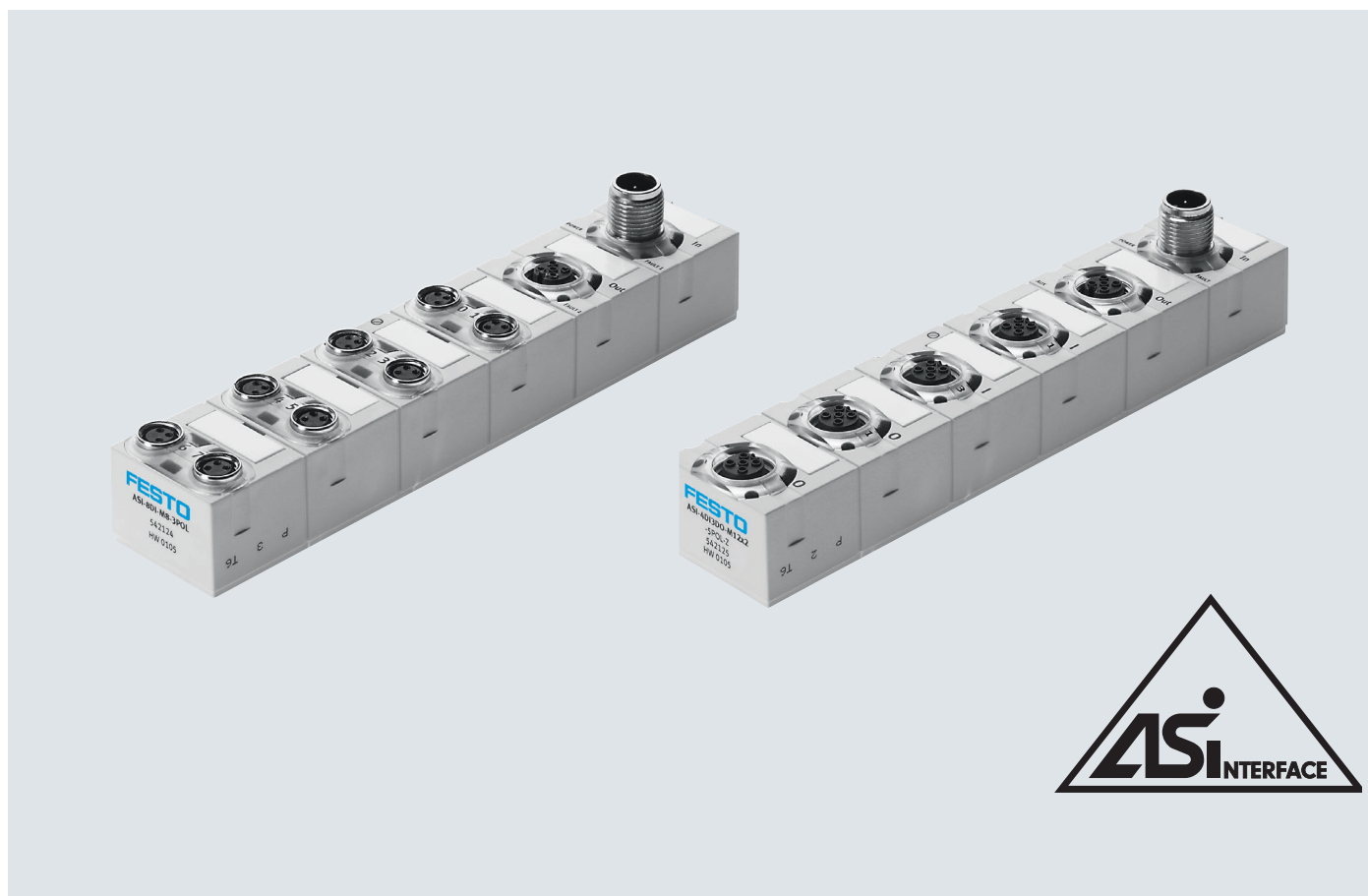
**Compact I/O modules to Spec. 2.1**

General description

- Highly compact modules
- Encapsulated, sturdy electronics
- Inputs/outputs to IEC 1131, PNP
- Short circuit proof, overload proof
- Inputs suitable for proximity switches, inductive, capacitive or optical sensors and light barriers
- Ideal for use in decentralised handling and assembly as well as universal applications with more demanding requirements
- AS-Interface Spec. 2.11
- A/B mode
- Bus and auxiliary power supply looped through via 2x M12
- Quick installation
- Diagnostics per module

Module with 8 inputs

- Two slaves in one housing
- 8 inputs M8, 3-pin, 200 mA per input
- Peripherals fault per slave, two fault LEDs
- Status indication per input
- Supply exclusively from "yellow" AS-Interface cable, pins for auxiliary supply are looped through only
- This makes it possible to cascade the input/output modules

Module with 4 inputs/3 outputs

- Individual slave
- 4 inputs M12, 5-pin, double allocation, 200 mA per input
- 3 outputs M12, 5-pin, double allocation, 1 A per output
- Peripherals fault, fault LED
- Status indication for each input and output
- Supply of inputs exclusively from "yellow" AS-Interface cable
- Supply of outputs exclusively from "black" AS-Interface cable

Compact I/O modules

Applications

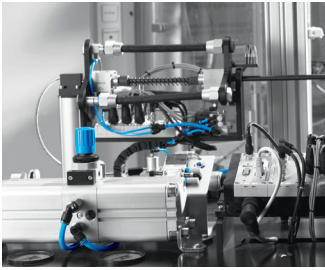

The M12 bus connection standardised in the AS-Interface specification offers a range of benefits:

- Use of standardised, pre-assembled M12 connecting cables
- One cable instead of two
- Quick M12 screw-type lock saves installation effort
- Flexible selection and optimisation of required cable qualities in areas with consistently high load, e.g. for
 - Energy chains
 - Robot arms (torsion)
 - Environments with high humidity
 - Aggressive media

This connection technology makes the compact modules ideally suited for use both in demanding and in very compact environments.

Decentralised machine and system structures, for example

- Handling technology
- Conveyor technology
- Packaging industry
- Sorting systems
- Upstream functions via energy chains and robot arms

Application tips

- Supplements valve terminals to optimise the number of inputs

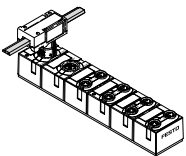

- Suitable for valve terminals with M12 bus connection to loop the bus through via M12

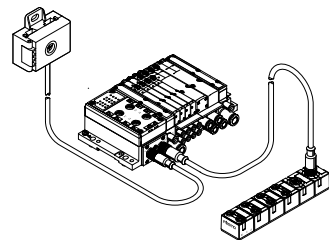

- Universal applications for all current sensors and light barriers up to 200 mA per channel

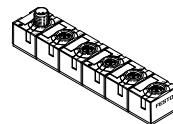

- Universal outputs of 1 A can be connected, with parallel switching in DUO plug up to 2 A (approx. 50 W)

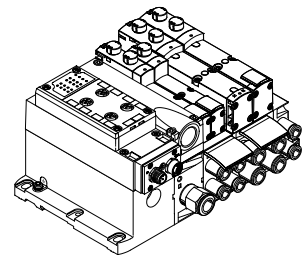

Compact I/O modules

AS-Interface flat cable distributor to round cable

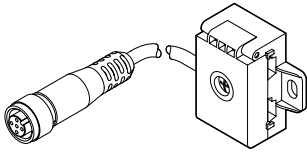

Alternative connection concepts

- Connection technology for AS-Interface for yellow and optionally for black flat cable
- Passive conversion of signals on M12 socket and round cable with M12 socket
- Pre-assembled round cable 1 m, PUR
- Optional PVC extension cable, or other suitable cable of any length, via additional M12 socket

Selecting the cable

It is easy to implement optimised connection technologies at the AS-Interface by choosing the appropriate cable:

- Flat cables for all standard applications with insulation displacement technology to reduce installation effort
- Round cables for applications with different requirements, e.g.:
 - Energy chains with a small radius and increased requirement for highly flexible cables

- Applications with consistently high humidity
- Applications in which a lot of cleaning takes place and in which cables that are resistant to cleaning agents are required (PUR, PVC or other cables)
- Cabling with standards (M12) preferred

Easy to assemble

Direct assembly on the wall or machine frame.

Tips for application and installation (inputs/outputs)

Input module 8DI-M8

Connection technologies using M8 take account of increasing miniaturisation.

Sensors with pre-assembled connecting cables M8 or with M8 plugs can be connected directly in a 1:1 connection.

This simplifies allocation and troubleshooting. Individual sensors or cables can be easily and quickly replaced in the event of faults.

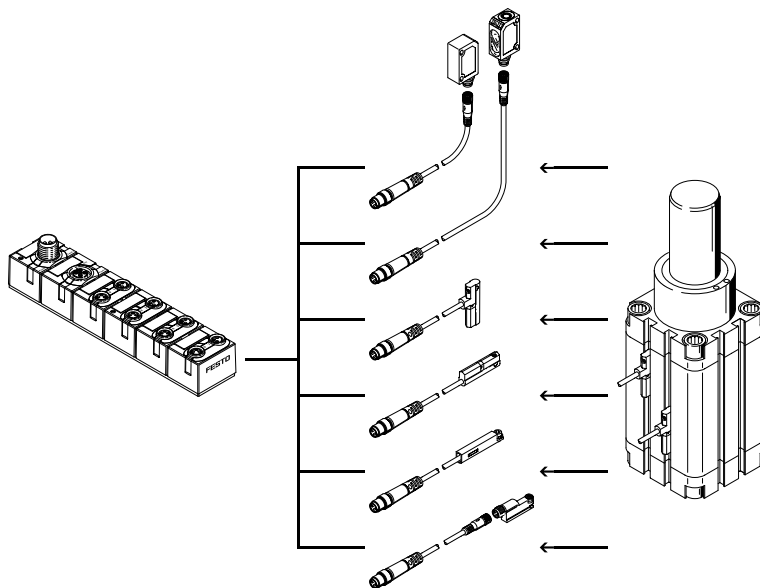

Compact I/O modules

Tips for application and installation (inputs/outputs)

Input/output module 4DI3DO-M12

Robust connection technology using M12 is a widely accepted standard for inputs and outputs. Direction connection for sensors with M12 connection. M12 interfaces with double allocation can be split using a DUO plug, DUO cable or T adapter as 2xM12 or 2xM8.

The standard for valves with central plug EN 60947-5-2 and ISO 20401 defines M12 and M8 with double allocation. This allows both a double solenoid valve and a single solenoid valve to be connected directly with a 1:1 connection to a compact AS-Interface module.

This simplifies allocation and troubleshooting. Individual valves or cables can be easily and quickly replaced in the event of faults.

Note

In the Festo modular system for connecting cables (NEBU...), adapter cables can be configured for M8 4-pin to M12 5-pin, so that even small valve plugs as in the case of MPA-S can be connected directly via pre-assembled cables.

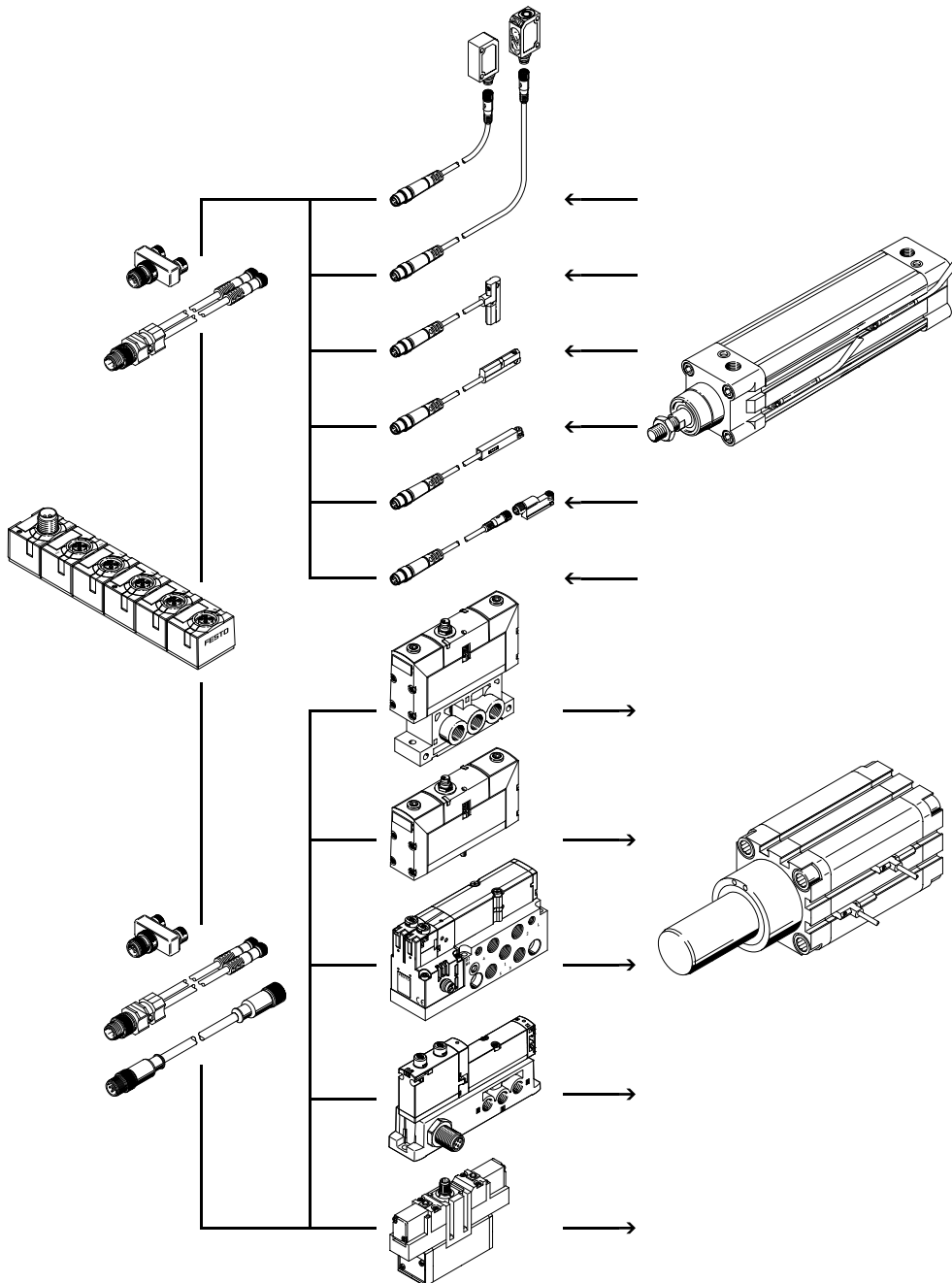

Compact I/O modules

Tips for application and installation (AS-Interface)

The compact I/O modules have 4-pin M12 connections for bus In and bus Out.

In line with the specification of the AS-Interface, both signal cables for the bus and optional auxiliary supply 24 V DC are incorporated in this one connection.

All 4 connections are looped through, allowing multiple modules and even downstream valve terminals to be cascaded.

Input module 8DI-M8

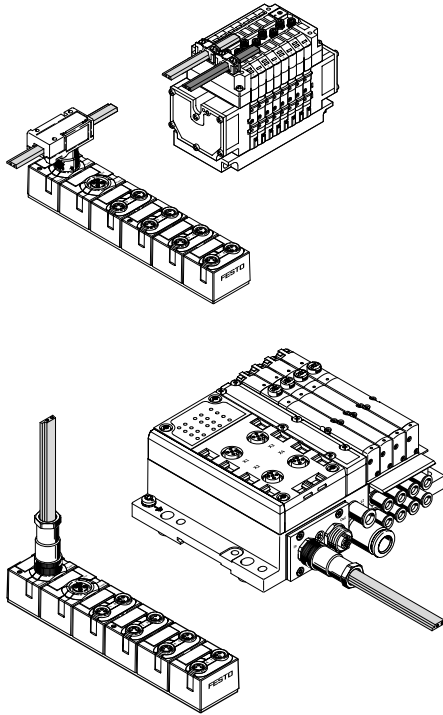

On this module, the supply of inputs is exclusively from the "yellow" AS-Interface cable, i.e. the pins for the auxiliary supply remain unused. This means the following alternative connection technologies can be implemented in addition to connections via M12 round plugs:

- Cable distributor NEFU-X2, mounted directly.
- Several directly adjacent modules can thus be connected to one another quickly and economically.
- A transition to valve terminals such as CPV is possible directly without converter.

If an input module is at the end of a strand, the flat cable can also be guided by a specially sealed fitting.

- Connection socket ASI-SD-PG-M12 mounted directly.
- Use on valve terminals with M12 is also possible, provided the auxiliary power supply is not required.

Input/output module 4DI3DO-M12

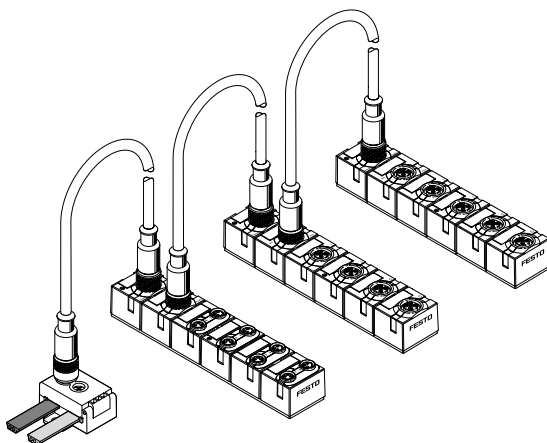

On this module, the supply of inputs is exclusively from the "yellow" AS-Interface cable, and the supply of outputs exclusively from the "black" AS-Interface cable. Supply takes place either completely via an M12 installation or via suitable converters, e.g. the flat cable distributor NEFU-X24F-M12G4.

Note
The contact load of an M12 pin is limited to 4 A. With cascaded modules, make sure that the maximum current load of the first M12 connection in a series is not exceeded, even in the worst case.

Compact I/O modules

Voltage drop on cables with M12 connection

Please note that the voltage drop on an M12 cable is higher than on the AS-Interface flat cable due to the smaller cable cross-sections.

The cable lengths must be designed according to the permissible voltage tolerances of the AS-Interface signal and the outputs for consuming devices with additional load voltage.

The graphs below give an initial impression (non-linear scaling of the cable length):

Voltage drop U for cable cross-section 0.34 mm² with M12

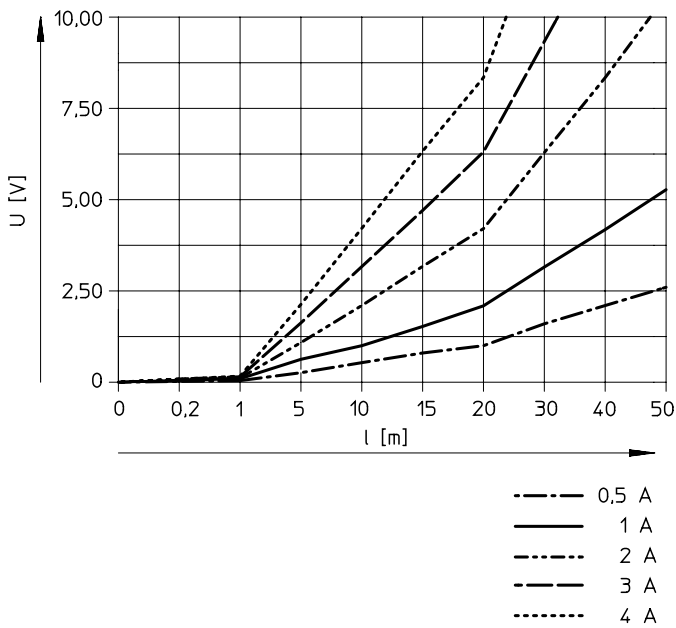

Voltage drop U for cable cross-section 0.25 mm² with M12

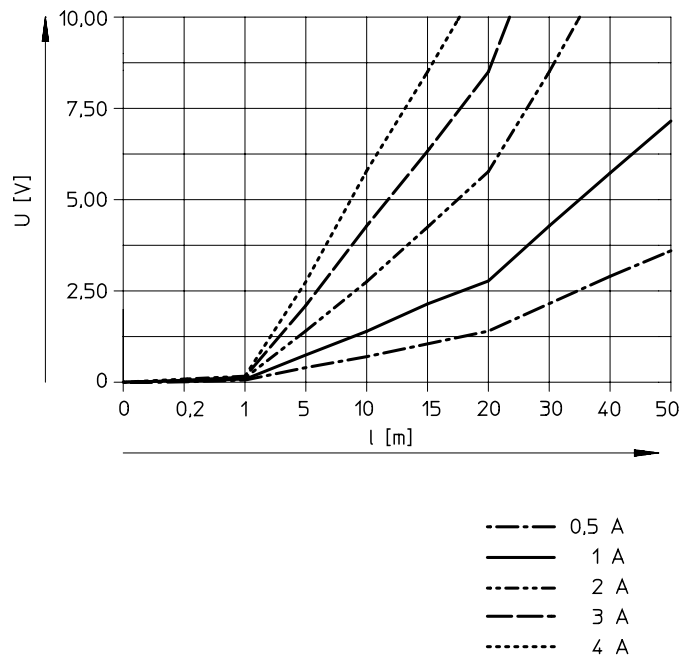

Compact I/O modules

Installation

Installation for consuming devices with higher current consumption

If several amperes are to be drawn per module, an appropriate supply must be provided over several distributors; see following example.

This allows the max. 3 A per module to be connected simultaneously.

In this case, also note that the voltage drop in the flat cables ($2 \times 1.5 \text{ mm}^2$) increases with large currents.

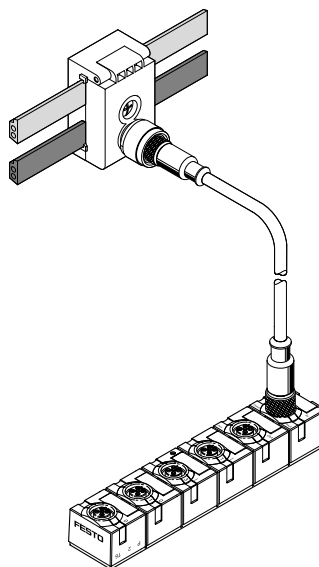
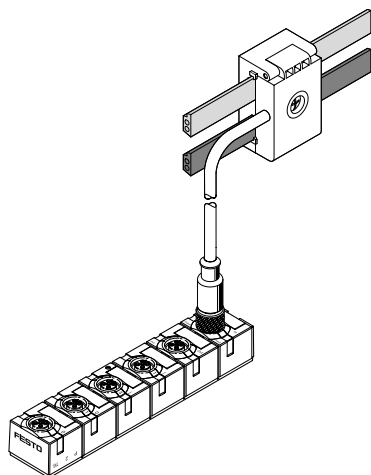

Alternative installation M12 with spurs

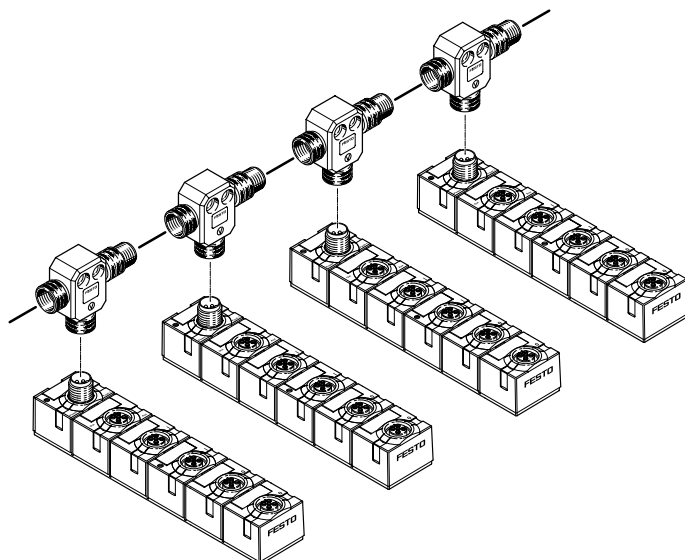

For a pure M12 installation, as an alternative to the looped-through AS-i bus, it is also possible to select an installation with spurs.

The T adapter FB-TA-M12-5POL is suitable for this purpose (bus In: socket, bus Out: plug).

Compact I/O modules

Mounting the compact AS-Interface modules

Wall mounting

The AS-Interface modules can be mounted on flat surfaces in almost any position using the existing mounting holes and two M4 screws.

- [Icon] - Note

The modules are protected against short circuit with a temperature fuse. In the event of a prolonged short circuit, the housing may reach temperatures of above 100°C.

The modules should therefore be mounted on a surface and in an environment that is designed for this temperature and where this will not trigger a risk of fire due to ignition (ATEX category T4 – up to 135°).

Wall mounting – Compact I/O modules

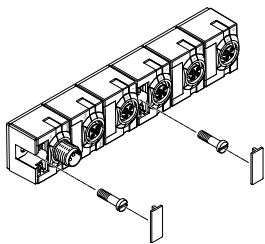

With the compact I/O modules, the mounting holes are covered by inscription labels.

Mounting on profiles (ITEM, etc.)

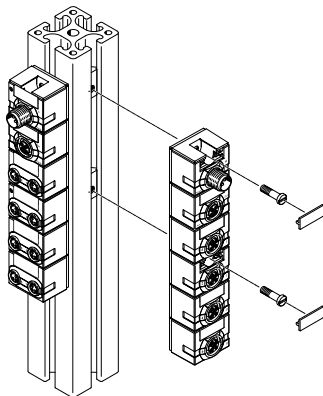

With slot nuts for M4, otherwise see wall mounting.

H-rail mounting

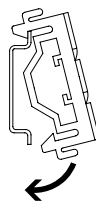
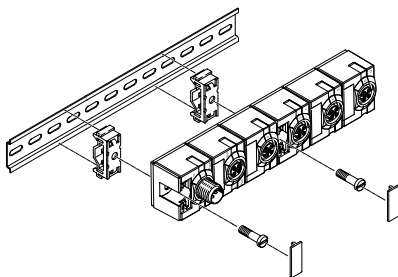

A mounting kit is available that can be used on an H-rail. On the compact CP modules, the mounting holes are covered by inscription labels.

The following mounting kit is needed for H-rail mounting:

- CP-TS-HS35

This enables mounting on H-rails to EN 60715.

Data sheet – Digital input module

Function

Digital input modules facilitate the connection of proximity switches or other digital 24 V DC sensors (inductive, capacitive, light barriers, etc.), PNP.

Area of application

- Input module for 24 V DC sensor signals
- Two slaves in one housing
- M8 plug, single allocation
- Indication of the input statuses for each input signal via LED
- 24 V DC supply for all connected sensors from the ("yellow") AS-Interface cable
- Peripherals fault LED for short circuit/undervoltage for each AS-Interface slave
- Modules support A/B mode to Spec. 2.11
- Bus connection 2x M12 for bus In and bus Out
- Bus and auxiliary supply looped through for cascading with output modules



Technical data – Digital inputs		ASI-8DI-M8-3POL
Type		ASI-8DI-M8-3POL
Number of inputs		8
Power supply 24 V DC		From the AS-Interface ("yellow" cable)
Intrinsic current consumption of electronics	[mA]	Typically 35 (inputs not connected)
Input current at 24 V DC (from sensor)	[mA]	Typically 6
Fuse protection for sensors and electronics modules		Internal thermal short circuit protection
Max. current consumption per sensor	[A]	0.24
Max. current consumption of the sensor supply, total current per slave	[A]	0.24
Nominal operating voltage for sensors	[V]	24
Operating voltage range for sensors	[V DC]	18 ... 30
Reverse polarity protection		For logic and sensor supply and AS-Interface
Galvanic isolation	between the channels to the AS-Interface system	None
Logic level	Signal 0	≤5
	Signal 1	≥-11
Input delay	[ms]	Typically 3
Switching logic		PNP
Input characteristic		To IEC 1131-2

Data sheet – Digital input module

General technical data		
Type	ASI-8DI-M8-3POL	
General	Degree of protection to EN 60529	IP65/IP67 (when fully plugged in or fitted with protective cap)
	Material	PBT
	Dimensions (LxWxD) [mm]	151 x 30 x 30
	Weight [g]	165
LED displays	Inputs	8 green
	AS-Interface LED	Power/green
	FAULT-LED (fault 1, fault 2)	Fault LED/red per slave
AS-Interface connection/load voltage connection	Connection to the AS-Interface	Via M12 connecting cables, 4-wire
	Watchdog function	Active after 50 ms
	Peripherals fault/diagnostics	Short circuit/overload (temperature fuse per channel) to specification c.S.2.1, two red fault LEDs Automatic voltage return
	AS-Interface bus voltage [V]	26.5 ... 31.6
	Total current consumption of AS-Interface [mA]	Max. 350
	Current-carrying capacity of M12 pins (AS-i, AUX) [A]	Max. 4
	AS-Interface IO code	0 _h
	AS-Interface ID code 1	A _h
	AS-Interface ID code 2	E _h
	AS-Interface profile	S-0.A.E
	AS-Interface address (factory setting)	#1A, #2A
	AS-Interface specification	2.11 (compatible with 3.0)

Operating and environmental conditions		
Type	ASI-8DI-M8-3POL	
Degree of protection to EN 60529	IP65/IP67 (when fully plugged in or fitted with protective cap)	
Ambient temperature [°C]	-5 ... +50	
Storage temperature [°C]	-20 ... +70	
Corrosion resistance class CRC ¹⁾	1	
CE marking (see declaration of conformity)	To EU EMC Directive ²⁾	
	To EU Explosion Protection Directive (ATEX)	
Certification	c UL us listed (OL)	

1) Corrosion resistance class CRC 1 to Festo standard FN 940070

Low corrosion stress. Dry indoor application or transport and storage protection. Also applies to parts behind covers, in the non-visible interior area, and parts which are covered in the application (e.g. drive trunnions).

2) For information about the area of use, see the EC declaration of conformity at: www.festo.com/sp → Certificates.

If the devices are subject to usage restrictions in residential, commercial or light-industrial environments, further measures for the reduction of the emitted interference may be necessary.

ATEX certifications		
ATEX category for gas	II 3G	
Type of ignition protection for gas	Ex nA IIC T4 X Gc	
ATEX category for dust	II 3D	
Type of ignition protection for dust	Ex tc IIIC T115°C X Dc IP67	
ATEX ambient temperature [°C]	-5 ≤ Ta ≤ +50	

 - **Note**

When operating device combinations in potentially explosive areas, the lowest common zone, temperature class and ambient temperature of the individual devices determine the possible use of the entire module.

Data sheet – Digital input module

Connection and display components

ASI-8DI-M8-3POL

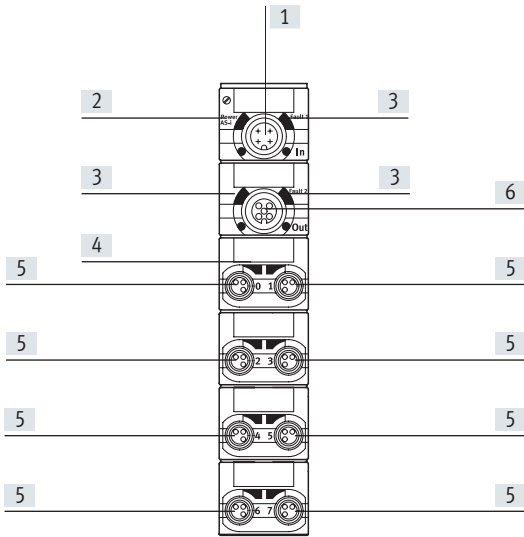

- [1] AS-interface connection, incoming
- [2] Status LED (green)
- [3] Red LED for short circuit/overload display
- [4] Green LED for status indication (one LED per input)
- [5] Sensor connections
- [6] AS-interface connection, outgoing

Pin allocation for sensor connections ASI-8DI-M8-3POL

	Pin	Signal	Designation	Pin	Signal
	1	24 V DC	Operating voltage 24 V DC	1	24 V
	3	0 V	Operating voltage 0 V	3	0 V
	4	Ix*	Sensor signal	4	Ix+1*

* Ix = Input x

Data sheet – Digital input/output module

Function

Combined digital input and output modules permit the connection of proximity switches or other 24 V DC sensors (inductive, capacitive, etc.) as well as up to 3 consuming devices 24 V DC/1 A. The electrical outputs activate actuators such as individual valves, lamps, signal equipment and many more.

Optimum actuation for valves with M12 central plug.

Plugs with double allocation are separated using a T adapter, DUO plug or DUO cable.

Area of application

- Input/output module for 24 V DC sensor signals and actuators, PNP
- Single slave
- M12 plug, 5-pin, double allocation
- Peripherals fault LED for short circuit/undervoltage of sensors or actuators
- Modules support A/B mode to Spec. 2.11
- Bus connection 2x M12 for bus In and bus Out
- Bus and auxiliary supply looped through for cascading with further output modules
- Indication of the input statuses for each input signal via LED
- 24 V DC supply for sensors from the ("yellow") AS-Interface cable
- Indication of the output statuses for each output signal via LED
- 24 V DC supply for actuators from the ("black") AS-Interface cable

**Technical data – Digital inputs**

Type	ASI-4DI3DO-M12x2-5POL-Z	
Number of inputs	4	
Power supply 24 V DC	From the AS-Interface ("yellow" cable)	
Intrinsic current consumption of electronics	[mA]	Typically 35 (inputs not connected)
Input current at 24 V DC (from sensor)	[mA]	Typically 6
Fuse protection for sensors	Internal thermal short circuit protection	
Max. current consumption per sensor	[A]	0.24
Max. current consumption of the sensor supply, total current per slave	[A]	0.25
Nominal operating voltage for sensors	[V]	24
Operating voltage range for sensors	[V DC]	18 ... 30
Reverse polarity protection	For logic and sensor supply and AS-Interface	
Galvanic isolation	between the channels	None
	to the AS-Interface system	Yes
Logic level	Signal 0	[V] ≤5
	Signal 1	[V] ≥ -11
Input delay	[ms]	Typically 3
Switching logic	PNP	
Input characteristic	To IEC 1131-2	

Data sheet – Digital input/output module

Technical data – Digital outputs		
Type		ASI-4DI3DO-M12x2-5POL-Z
Number of outputs		3
Allocation of outputs		Socket 3 with double allocation, socket 4 with single allocation
Design of actuator connection		4x M12, 5-pin
Power supply 24 V DC		From the auxiliary power supply, "black" AS-interface cable
Max. output current per channel	[A]	1.0, 2 outputs can be switched together
Operating voltage	[V DC]	24 ±25%
Fuse protection for power output		Internal thermal short circuit protection for each output
Reverse polarity protection		For actuator supply 24 V/0 V
Switching logic		PNP
Output characteristic		To ICE 1131-2
Galvanic isolation	between the channels	None
	to the AS-Interface system	Yes
Voltage drop across the output	[V]	1.5
Limitation of inductive switch-off voltage	[V]	-10 ... -45
General technical data		
Type		ASI-4DI3DO-M12x2-5POL-Z
LED displays	Inputs	4 green
	Outputs	3 yellow
	AS-Interface LED	Power/green
	AUX-PWR LED	Auxiliary power supply/green
	FAULT LED	Fault LED/red
General	Degree of protection to EN 60529	IP65/IP67 (when fully plugged in or fitted with protective cap)
	Material	PBT
	Dimensions (LxWxD)	[mm] 151 x 30 x 30
	Weight	[g] 165
AS-Interface connection/load voltage connection	Connection to the AS-Interface	Via M12 connecting cables, 4-wire
	Watchdog function	Active after 50 ms
	Peripherals fault/diagnostics	Short circuit/overload (temperature fuse per channel) to specification C.S.2.1, two red fault LEDs Automatic voltage return
	AS-Interface bus voltage	[V] 26.5 ... 31.6
	Total current consumption of AS-Interface	[mA] Max. 250
	Current-carrying capacity of M12 pins (AS-Interface, AUX)	[A] Max. 4
	AS-Interface IO code	7 _h
	AS-Interface ID code 1	A _h
	AS-Interface ID code 2	2 _h
	AS-Interface profile	S-7.A.2
	AS-Interface address (factory setting)	#0A
	AS-Interface specification	2.11 (compatible with 3.0)

Data sheet – Digital input/output module

Operating and environmental conditions		ASI-4DI3DO-M12x2-5POL-Z
Type		ASI-4DI3DO-M12x2-5POL-Z
Degree of protection to EN 60529		IP65/IP67 (when fully plugged in or fitted with protective cap)
Ambient temperature	[°C]	-5 ... +50
Storage temperature	[°C]	-20 ... +70
Corrosion resistance class CRC ¹⁾		1
CE marking (see declaration of conformity)		To EU EMC Directive ²⁾ To EU Explosion Protection Directive (ATEX)
Certification		c UL us listed (OL)
Note on materials		RoHS-compliant
PWIS criterion		Free of paint-wetting impairment substances

- 1) Corrosion resistance class CRC 1 to Festo standard FN 940070
Low corrosion stress. Dry indoor application or transport and storage protection. Also applies to parts behind covers, in the non-visible interior area, and parts which are covered in the application (e.g. drive trunnions).
- 2) For information about the area of use, see the EC declaration of conformity at: www.festo.com/sp → Certificates.
If the devices are subject to usage restrictions in residential, commercial or light-industrial environments, further measures for the reduction of the emitted interference may be necessary.

ATEX certifications		
ATEX category for gas		II 3G
Type of ignition protection for gas		Ex nA IIC T4 X Gc
ATEX category for dust		II 3D
Type of ignition protection for dust		Ex tc IIIC T115°C X Dc IP67
ATEX ambient temperature	[°C]	-5 ≤ Ta ≤ +50

Note

When operating device combinations in potentially explosive areas, the lowest common zone, temperature class and ambient temperature of the individual devices determine the possible use of the entire module.

Connection and display components

ASI-4DI3DO-M12x2-5POL-Z

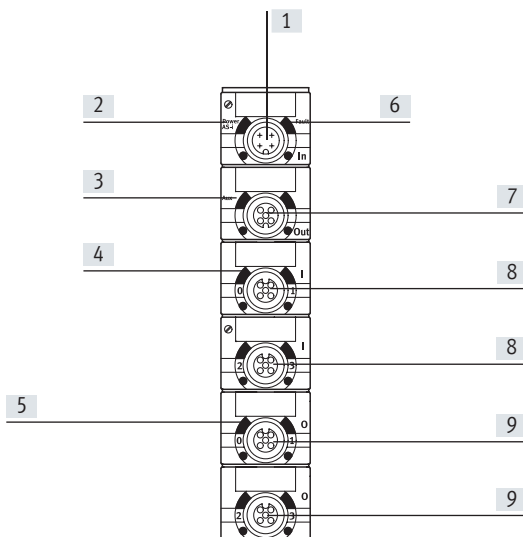

- [1] AS-interface connection, incoming
- [2] Status LED (green)
- [3] Green LED for load voltage indication
- [4] Green LED for status indication (one LED per input)
- [5] Yellow LED for status indication (one LED per input)
- [6] Red LED for short circuit/overload display
- [7] AS-interface connection, outgoing
- [8] Sensor connections
- [9] Outputs

Data sheet – Digital input/output module

Pin allocation for sensor connections ASI-4DI3DO-M12X2-5POL-Z

Terminal allocation	Pin	Signal	Designation
	1	24 V DC	Operating voltage 24 V DC
	2	Ix*+1	Sensor signal
	3	0 V	Operating voltage 0 V
	4	Ix*	Sensor signal
	5	Ground	Earth terminal

* Ix = Input x

Pin allocation for outputs ASI-4DI3DO-M12X2-5POL-Z

Terminal allocation	Output 1 and 2			Output 3		
	Pin	Signal	Designation	Pin	Signal	Designation
	1	n.c.	Not connected	1	n.c.	Not connected
	2	Ox*+1	Output	2	n.c.	Not connected
	3	0 V	Operating voltage 0 V	3	0 V	Operating voltage 0 V
	4	Ox*	Output	4	Ox*+2	Output
	5	Ground	Earth terminal	5	Ground	Earth terminal

* Ox = Output

Dimensions

ASI-8DI-M8-3POL

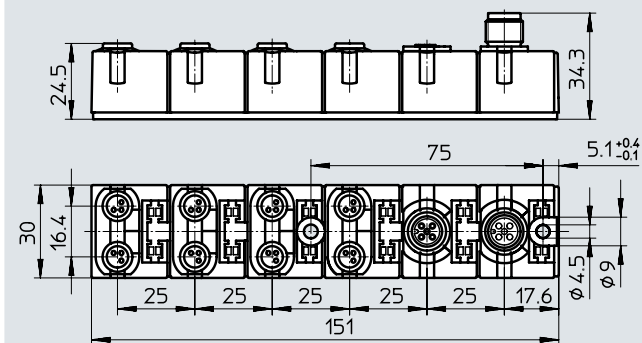





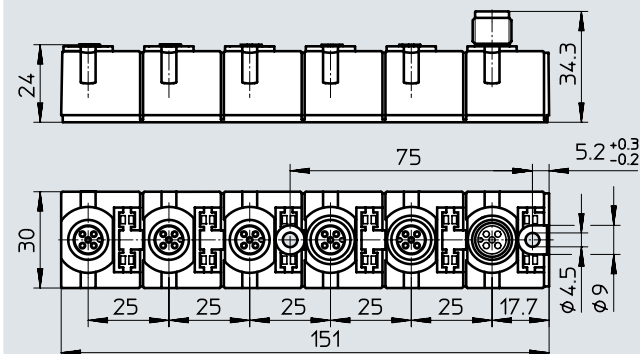

Download CAD data → www.festo.com

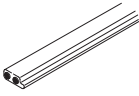

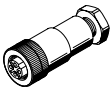
ASI-4DI3DO-M12x2-5POL-Z

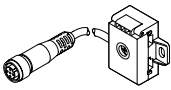

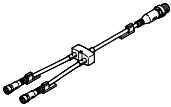

Data sheet – Compact I/O modules

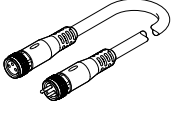
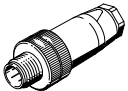
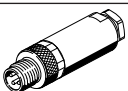
Ordering data		Designation	Part no.	Type
Bus connection				
	AS-Interface flat cable, yellow	100 m	18940	KASI-1.5-Y-100
	AS-Interface flat cable, black	100 m	18941	KASI-1.5-Z-100
	Cable cap for flat cable (pack of 50)		18787	ASI-KK-FK
	Cable sleeve (pack of 20)		165593	ASI-KT-FK
	M12 socket, 4-pin	For AS-Interface flat cable	18789	ASI-SD-PG-M12
Cable distributor				
	AS-Interface data to socket M12, 4-pin		572225	NEFU-X22F-M12G4
	AS-Interface data and load voltage supply to socket M12, 4-pin		572226	NEFU-X24F-M12G4
	AS-Interface data and load voltage supply to socket M12, 4-pin, cable length 1 m		572227	NEFU-X24F-1-M12G4
Push-in T-connector				
	T adapter for DH-485, M12 5-pin		171175	FB-TA-M12-5POL
	Plug M12, A-coded, 4-pin	2x socket M12, A-coded, 5-pin	8005310	NEDY-L2R1-V1-M12G5-N-M12G4
		2x socket M8, A-coded, 3-pin	8005311	NEDY-L2R1-V1-M8G3-N-M12G4
	Modular system for all types of sensor/actuator distributor → Internet: nedy		–	NEDY-...

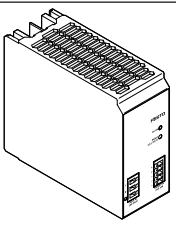
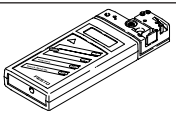
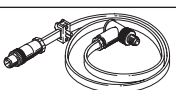
Data sheet – Compact I/O modules

Ordering data		Designation	Part no.	Type
Connecting cable				
	Modular system for a choice of connecting cables → Internet: nebu		–	NEBU-...
	Straight plug M8, 3-pin, straight socket M8, 3-pin	0.5 m	541346	NEBU-M8G3-K-0.5-M8G3
		1.0 m	541347	NEBU-M8G3-K-1-M8G3
		2.5 m	541348	NEBU-M8G3-K-2.5-M8G3
		5.0 m	541349	NEBU-M8G3-K-5-M8G3
Straight plug M12, 4-pin, straight socket M12, 5-pin	0.5 m	8000208	NEBU-M12G5-K-0.5-M12G4	
DUO plug				
	Plug M12 for 2 connecting cables	4-pin, PG11	18779	SEA-GS-11-DUO
		5-pin, PG11	192010	SEA-5GS-11-DUO
Sensor plug				
	Straight plug, M12	4-pin, PG7	18666	SEA-GS-7
		4-pin, PG9	18778	SEA-GS-9
		4 pin, for 2.5 mm cable ø	192008	SEA-4GS-7-2.5
		5-pin, PG7	175487	SEA-M12-5GS-PG7
	Straight plug, M8, 3-pin	Screw-in	192009	SEA-3GS-M8-S
		Solderable	18696	SEA-GS-M8
	Cover cap (pack of 10)	M8	177672	ISK-M8
		M12	165592	ISK-M12
Other				
	Primary switched-mode, modular power supply 24 V DC power supply	5 A	2247681	CACN-3A-1-5
		10 A	2247682	CACN-3A-1-10
	Addressing device (power supply plug included in the scope of delivery)		18959	ASI-PRG-ADR
	Addressing cable		18960	KASI-ADR

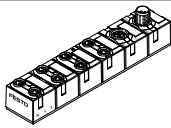
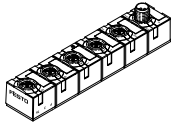
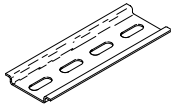
Data sheet – Compact I/O modules

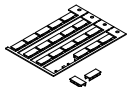
Ordering data		Part no.	Type
Designation			
Input/output modules			
	AS-Interface input module for 8 inputs M8, compact	542124	ASI-8DI-M8-3POL
	AS-Interface input/output module for 4 inputs/3 outputs M12, compact	542125	ASI-4DI3DO-M12X2-5POL-Z
Mounting			
	H-rail to EN 60715	35430	NRH-35-2000
	Mounting for H-rail	170169	CP-TS-HS35
Inscription labels			
	Inscription labels 8x20 mm, in frame (pack of 20)	539388	IBS-8x20

Data sheet – Addressing device

Addressing device ASI-PRG-ADR

- Parameterisation of AS-Interface components
- Display and editing of addresses, input and output signals
- Corresponds to AS-Interface SPEC 3.0



Description

Before an AS-Interface network is commissioned, addresses must be assigned to the connected slaves. These addresses are stored in an EEPROM chip on each slave. Each slave is connected to the addressing device for the allocation of an address. Addressing is simple and is carried out using 5 keys. The main advantages are:

- Compact design
- Can be addressed on-site
- Supports AS-Interface specification S 7.7.A.7 (SPEC 3.0), S 0.B and S 7.B (AS-Interface Safety at Work)

Using the addressing device according to SPEC 3.0, it is possible to scan the AS-Interface from any chosen point in the network. At all connected stations:

- Slave addresses can be read/changed
- ID and IO codes can be read out
- Parameters can be read/changed
- Input/output data can be read and written (setting outputs)
- Error messages can be read out and quickly recognised

Independent of power sources

- Battery operation

Simple reading of error codes

- LCD display

Reliable

- Short-circuit proof
- Overload-proof

Universal adapter connection suitable for a large number of AS-Interface slaves. Additional addressing cable for slaves with M12 round plug or flat cable socket optionally available.

General technical data

Display		LCD display
Control elements		Membrane keypad
		5 buttons
No. of function keys		5
Dimensions W x L x H	[mm]	34 x 210 x 80
Product weight	[g]	610

Technical data – Electrics

Nominal operating voltage	[V DC]	28
Permissible load current	[mA]	100
Power supply		Lithium battery
Short circuit current rating		Yes
Overload protection		Provided

Technical data – Fieldbus interface

Protocol		AS-Interface SPEC 3.0
Connection type		Socket
Connection technology		M12x1, A-coded
Number of pins/wires		5
Based on standard		To EN 61076-2-101

Data sheet – Addressing device

Materials	
Housing	PA-reinforced
Note on materials	RoHS-compliant

Operating and environmental conditions	
Ambient temperature	[°C] 0 ... +40
Degree of protection	IP20
CE marking (see declaration of conformity) ²⁾	To EU EMC Directive ¹⁾

- 1) For information about the area of use, see the EC declaration of conformity at: www.festo.com/sp → Certificates.
 If the devices are subject to usage restrictions in residential, commercial or light-industrial environments, further measures for the reduction of the emitted interference may be necessary.
- 2) Additional information is available at www.festo.com/sp → Certificates.

Dimensions

Download CAD data → www.festo.com

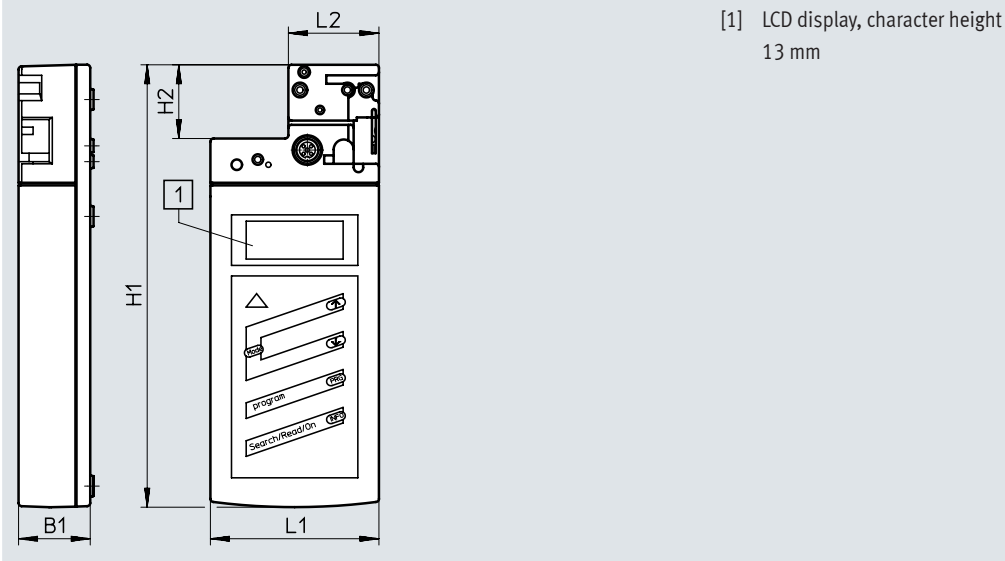

	B1	H1	H2	L1	L2
ASI-PRG-ADR	34	210	35	80	43

Ordering data

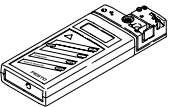
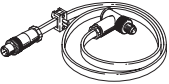
	Designation	Part no.	Type
	Addressing device	18959	ASI-PRG-ADR
	Addressing cable	18960	KASI-ADR

Accessories

Overview of cables

Addressing cable – KASI-ADR

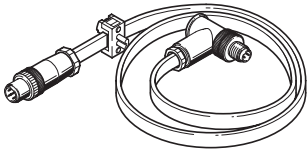

With the addressing cable ASI-ADR, available as accessory, any number of slaves can be addressed, either directly via the flat cable connection (FK) or the M12 connection (M12):

- Individual valve interface (FK)
- Compact I/O modules (M12)
- CPV valve terminals (FK)
- SPC11 Soft Stop (FK)

Flat cable – KASI-1.5-...-100

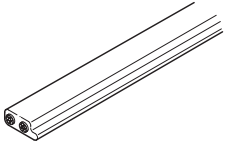

The flat cable is designed with two wires. The coding strip prevents reverse polarity.

Stations on the AS-Interface network are connected to the flat cable by contact pins using insulation displacement technology – without stripping the cable and wire casing.

The yellow cable is preferably used for the AS-Interface network and the black for the auxiliary supply.

Connecting cable NEBU-M12...-M12...

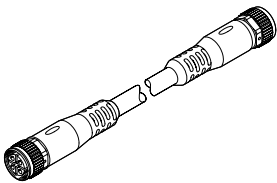

The round cables are designed with 4 wires and protected against reverse polarity. Standardised connection technology replaces the yellow/black AS-Interface with a common cable.

- Fixed lengths: 0.2 m, 1 m, 2.5 m and 5 m ex-stock
- NEBU modular system for connecting cables

Note
Define your own connecting cable. Select M8 (3- or 4-pin) or M12 (4- or 5-pin) at each end as required and specify the desired cable length and quality – Festo delivers to your specifications.

→ www.festo.com

Flat cable sleeve – ASI-KT-FK



For insulating and sealing the AS-Interface cable at the end of the string

- Degree of protection IP65
- Shrinks with the application of heat (hot-air gun or similar)

Cable cap – ASI-KK-FK



For insulating and sealing the AS-Interface cable at the end of the string

- Degree of protection IP65

Accessories

Dimensions

Download CAD data → www.festo.com

Addressing cable – KASI-ADR

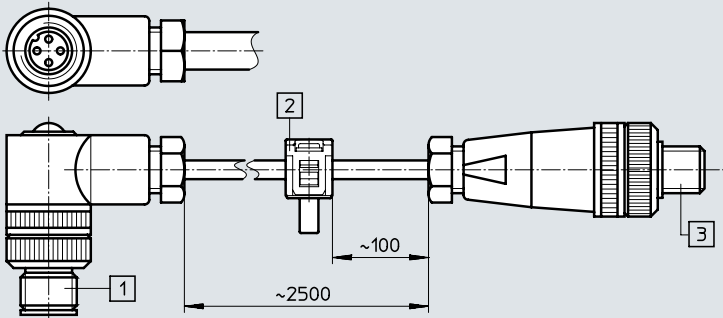

- [1] Round plug for connection to addressing device
- [2] Flat cable socket for connecting stations on the AS-Interface network with plug-in connection
- [3] Flat cable socket with M12 plug connection for stations on the AS-Interface network with M12 interface

Flat cable – KASI-1.5-...-100

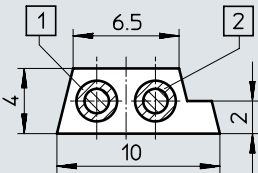

- [1] Blue (-)
- [2] Brown (+)

Flat cable sleeve – ASI-KT-FK

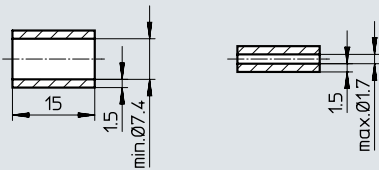

Cable cap – ASI-KK-FK

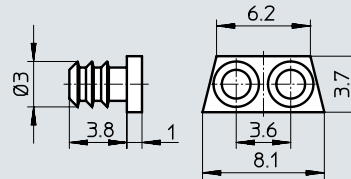

Accessories

Overview of connection components

Flat cable socket

Flat cable socket for connecting stations on the AS-Interface network to the flat cable.

The connection is detachable. The cable socket is protected against reverse polarity.

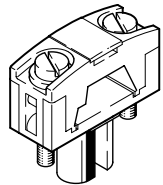

ASI-SD-FK

Flat cable socket for valve terminals CPV

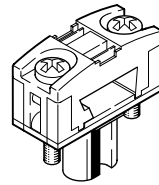

ASI-SD-FK180

Overhead leadthrough for flat cable version FK180.

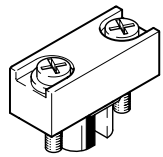

ASI-SD-FK-BL

Blanking plug for sealing unused connections for flat cable sockets.

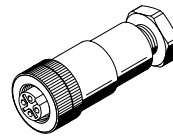

ASI-SD-PG-M12

Flat cable socket with M12 connection and special seal for the flat cable in a PG connector. For compact input module (ASI-8DI-M8-3POL).

Flat cable distributor

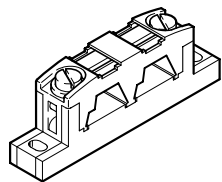

ASI-KVT-FK

Rotatable flat cable distributor, for branching the flat cable to stations on the AS-Interface network at any desired point on the flat cable.

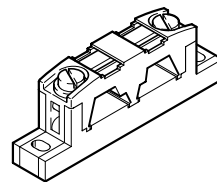

ASI-KVT-FK-S

Symmetrical flat cable distributor: this distributor can be used to rotate the profile lug by 180° when changing from one cable to another. This prevents laying the cables in a loop. Three cable caps are included in the scope of delivery to cap the cable ends.

Cable distributor

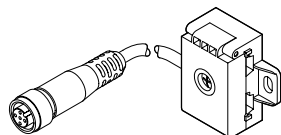

NEFU-X2

Flat cable socket with M12 connection as leadthrough for the flat cable. Can be plugged into 4-pin and 5-pin interfaces.

Accessories

Overview of distributors

Push-in T-connector NEDY

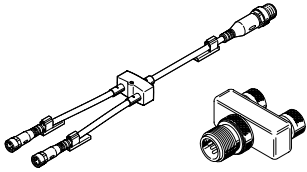

The sensor/actuator distributors NEDY each combine two sensor signals on a 4-pin plug.

These are routed on a 4- or 5-pin input socket of a valve terminal or the compact I/O module.
Any version and cable length can be configured:

→ Internet: nedy

DUO plug – SEA-5GS11-DUO

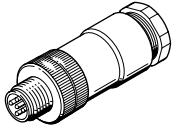

Each DUO plug conveniently combines two sensor or actuator signals/cables in one housing.

Overview of other connecting cables

Extension cable – NEBU

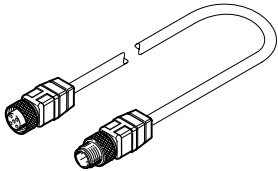

The connecting cables can be used for length compensation between a distributor and the inputs of a valve terminal or a compact I/O module.

They can also be used as AS-Interface bus cables for M12 connection technology.

Any version and cable length can be configured:

→ Internet: nebu

Overview of other accessories

Inscription labels IBS-...

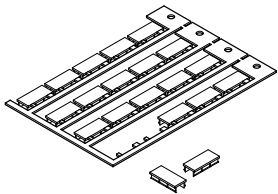

Convenient labelling system for





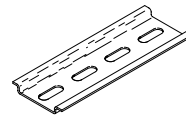

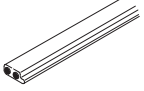

- Flat cable sockets
- Flat cable distributor
- Individual valve interfaces
- Compact I/O modules
- Valve terminals CPV

H-rail NRH-35-2000



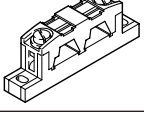
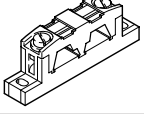

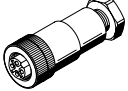

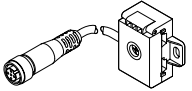

- For compact I/O modules
- Valve terminals CPV
- For individual valve interfaces
- AS-Interface power supply units

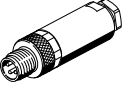
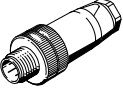
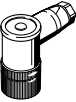

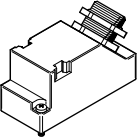

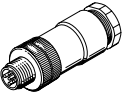
Accessories

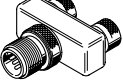
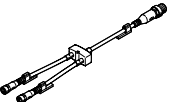
Ordering data		Designation	Part no.	Type
Bus connection				
	AS-Interface flat cable, yellow	100 m	18940	KASI-1.5-Y-100
	AS-Interface flat cable, black	100 m	18941	KASI-1.5-Z-100
	Flat cable socket		18785	ASI-SD-FK
	Flat cable socket	Turned 180°	196089	ASI-SD-FK180
	Flat cable dummy plug		196090	ASI-SD-FK-BL
	AS-Interface flat cable distributor	Rotatable cable	18786	ASI-KVT-FK
	AS-Interface flat cable distributor	Symmetrical cable	18797	ASI-KVT-FK-S
	Cable cap for flat cable (pack of 50)		18787	ASI-KK-FK
	Cable sleeve (pack of 20)		165593	ASI-KT-FK
	M12 socket, 4-pin	For AS-Interface flat cable	18789	ASI-SD-PG-M12
	M12 socket, 5-pin	For round cable	18324	FBSD-GD-9-5POL
Cable distributor				
	AS-Interface data to socket M12, 4-pin		572225	NEFU-X22F-M12G4
	AS-Interface data and load voltage supply to socket M12, 4-pin		572226	NEFU-X24F-M12G4
	AS-Interface data and load voltage supply to socket M12, 4-pin, cable length 1 m		572227	NEFU-X24F-1-M12G4

Accessories

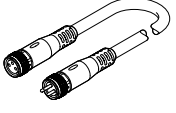
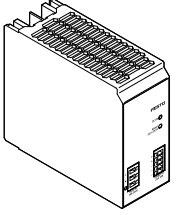
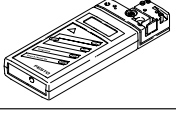
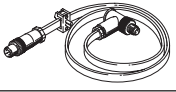
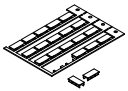
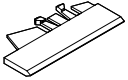
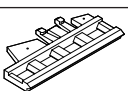
Ordering data	Designation		Part no.	Type
Sensor plug				
	Straight plug, M8, 3-pin	Screw-in	192009	SEA-3GS-M8-S
		Solderable	18696	SEA-GS-M8
	Straight plug, M12	4-pin, PG7	18666	SEA-GS-7
		4-pin, PG9	18778	SEA-GS-9
		4 pin, for 2.5 mm cable ø	192008	SEA-4GS-7-2.5
		5-pin, PG7	175487	SEA-M12-5GS-PG7
	Angled sensor plug	M12, 4-pin	12956	SIE-WD-TR
	Harax plug	4-pin	525928	SEA-GS-HAR-4POL
	Sub-D plug	25-pin	527522	SD-SUB-D-ST25
	Cover cap (pack of 10)	M12	165592	ISK-M12
		M8	177672	ISK-M8
DUO plug				
	Plug M12 for 2 connecting cables	4-pin	18779	SEA-GS-11-DUO
		5-pin	192010	SEA-5GS-11-DUO
Push-in T-connector				
	T adapter for DH-485, M12 5-pin		171175	FB-TA-M12-5POL
	Plug M12, A-coded, 4-pin	2x socket M12, A-coded, 5-pin	8005310	NEDY-L2R1-V1-M12G5-N-M12G4
		2x socket M8, A-coded, 3-pin	8005311	NEDY-L2R1-V1-M8G3-N-M12G4
	Modular system for all types of sensor/actuator distributor → Internet: nedy		–	NEDY-...

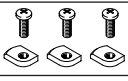
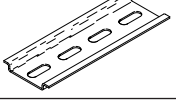
Accessories

Ordering data		Designation	Part no.	Type
Connecting cable				
	Modular system for a choice of connecting cables → Internet: nebu		–	NEBU-...
	Straight plug M8, 3-pin, straight socket M8, 3-pin	0.5 m	541346	NEBU-M8G3-K-0.5-M8G3
		1.0 m	541347	NEBU-M8G3-K-1-M8G3
		2.5 m	541348	NEBU-M8G3-K-2.5-M8G3
		5.0 m	541349	NEBU-M8G3-K-5-M8G3
	Straight plug M12, 4-pin, straight socket M12, 5-pin	0.5 m	8000208	NEBU-M12G5-K-0.5-M12G4
Connecting cable, straight plug, straight socket	M12, 8-pin, 2.0 m	525617	KM12-8GD8GS-2-PU	
Other				
	Primary switched-mode, modular power supply 24 V DC power supply	5 A	2247681	CACN-3A-1-5
		10 A	2247682	CACN-3A-1-10
	Addressing device		18959	ASI-PRG-ADR
	Addressing cable		18960	KASI-ADR
Inscription labels				
	Inscription labels in frame	8x20 mm (pack of 20)	539388	IBS-8x20
		6x10 mm (pack of 64)	18576	IBS 6x10
		9x20 mm (pack of 20)	18182	IBS 9x20
	For foil Inscription label holder for sub-base, transparent, for paper foil label	Can be used for VMPA1 VMPA2	533362	VMPA1-ST-1-4
		Can be used for VMPA14	8085996	VMPA14-ST-1-4
	For IBS Inscription label holder for sub-base, 4-part, for IBS 6x10	Can be used for VMPA1 VMPA2	544384	VMPA1-ST-2-4
		Can be used for VMPA14	8085997	VMPA14-ST-2-4
Mounting material				
	Mounting for H-rail		170169	CP-TS-HS35
	Mounting for H-rail		526032	CPX-CPA-BG-NRH
	H-rail to EN 60715		35430	NRH-35-2000
	Mounting bracket		534416	VMPA-BG-RW