

Control block CPX-CEC

FESTO



Key features

Application

Controllers



The CODESYS controllers are modern control systems for CPX terminals that enable programming with CODESYS to IEC 61131-3.

Programming in a global language

CODESYS provided by Festo offers a convenient user interface with the following functions:

- Integrated module libraries
- Library Manager for integrating further libraries
- Visualisation editor

- Simulation mode
- Integrated project documentation
- Debugging functions for fault finding
- Configuration and parameterisation of the controller using the control configuration

Basic functions

The CODESYS controllers offer the following basic functions:

- Programming with CODESYS to IEC 61131-3
- Communication via Ethernet (Modbus/TCP, EasyIP, TCP/IP)
- Process visualisation using operator unit CDPX or OPC server
- Communication via fieldbus in combination with a bus node in the CPX terminal
- Diagnostics and quick commissioning of CPX modules via handheld CPX-FMT

CPX-CEC-C1 offers

- All basic functions
- CANopen master for controlling up to 127 CANopen stations. Electric axes can be controlled in point-to-point mode

CPX-CEC offers

- All basic functions
- RS232 interface for operating external devices



Note

When using third-party devices, data communication must be programmed by the user.

Bus connection

The CODESYS controllers are remote controllers that can be connected to a higher-order PLC via the bus nodes of the CPX terminal or via Ethernet, for example:

- PROFINET
- EtherNet/IP
- EtherCAT
- PROFIBUS
- DeviceNet

Operating modes

- Stand-alone
- Remote controller on the fieldbus
- Remote controller on Ethernet

System expansion

CANopen connects CPX-CEC with valve terminals and electric drive controllers from Festo:

- CPX, CPV
- CMMP-AS, CMMS-ST, etc.
- AS-Interface gateway

Ethernet connects CPX-CEC with additional controllers and operator units from Festo:

- CDPX
- Camera SBO...-Q

Key features

Advantages for users

Increased performance

Improved cycle times – more connectable actuators.
Compatibility with almost all control systems on the market is ensured via the CPX terminal.

The extensive CODESYS function library provides diagnostics and condition monitoring options.

Reduced costs

For standardised preprocessing: reduces installation costs as an intelligent remote I/O terminal to IP65/IP67 directly at the machine.

CPX-CEC is ideally adapted to CPX and motion applications with up to 31 axes.

Simple, yet efficient: decentralised structures

The modular I/O system with up to 512 I/Os and CAN master functionality (CPX-CEC) offers complete flexibility,

whether for open- and closed-loop control, stand-alone for economical automation (e.g. of manual work stations) or remote control with preprocessing.

The only one in the world to IP65

The fully integrated automation platform for standard, proportional and servo-pneumatic, sensor and motion control to IP65.

And commissioning is really easy.

Classification of CPX-CEC in the portfolio for multi-axis controllers for electric drive technology

CPX-CEC in the world of electric drive technology

Embedded controller

CPX-CEC permits the flexible connection of valve actuators and electric drives on the terminal. It is programmable in CODESYS and can, if necessary, be directly installed at the machine to IP65. The ideal complement to the gateway module CPX-CM-HPP.

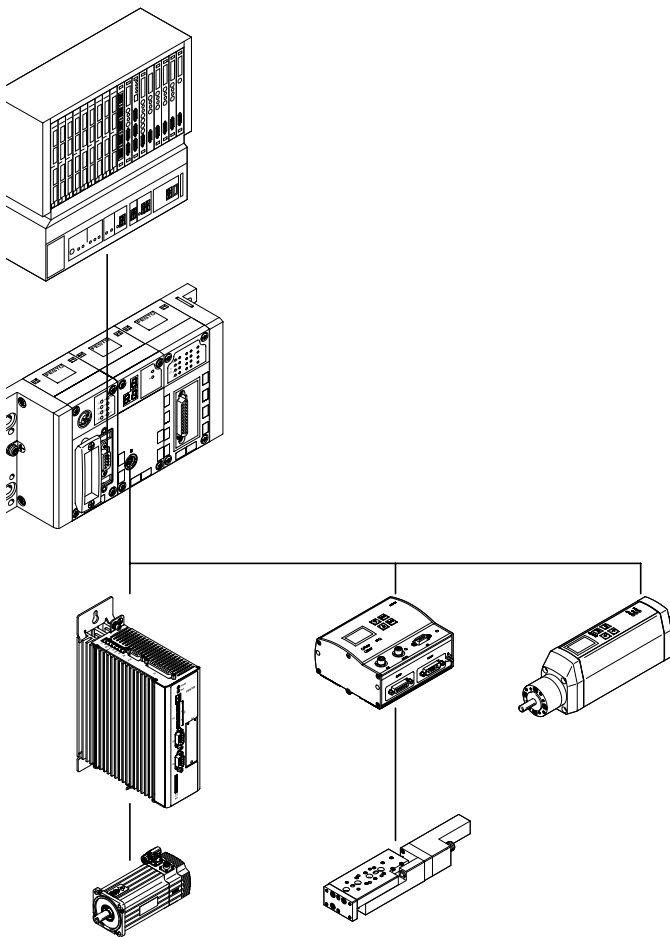

Data sheet

- Industrial Ethernet
- TCP/IP
- EasyIP
- Web interface
- Email
- Data transfer

The CODESYS controller is a modern control system for CPX terminals that enables programming with CODESYS to IEC 61131-3.

The power supply to and communication with other modules takes place via the interlinking block.

In addition to network connections, LEDs are also provided for the bus status, operating status of the PLC and CPX peripherals information, as are switching elements and a diagnostic interface for CPX-FMT.



Application

Bus connection

The CPX-CEC is a remote controller that can be connected to a higher-order PLC via the bus nodes of the CPX terminal or via Ethernet.

At the same time, it is possible to operate the CPX-CEC as a compact stand-alone controller directly on the machine.

Communication protocols

- Fieldbus via CPX bus nodes
- Modbus/TCP
- EasyIP

Operating modes

- Stand-alone
- Remote controller, fieldbus
- Remote controller, Ethernet

Setting options

The CPX-CEC has the following interfaces for monitoring, programming and commissioning:

- For the CPX-FMT
- Ethernet interface for IT applications
- Remote diagnostics

The operating mode and fieldbus protocol are set using the DIL switch on the CPX-CEC.

The integrated web server offers a convenient means of querying data saved in the CPX-CEC.

Features

- Easy control of valve terminal configurations with MPA, VTSA
- Diagnostics with flexible monitoring options for pressure, flow rate, cylinder operating time, air consumption

- Activation of decentralised installation systems on the basis of CPI control of applications in proportional pneumatics
- AS-Interface control via gateway

- Connection to all fieldbuses as a remote controller and for pre-processing
- Control of electric actuators as individual axes via CANopen (CPX-CEC-C1/-M1)

- Early warnings and visualisation options
- Servo-pneumatic applications

Data sheet

General technical data		
Protocol	CODESYS Level 2	
	EasyIP	
	Modbus TCP	
	TCP/IP	
Processing time	Approx. 200 µs/1 k instructions	
Programming software	CODESYS provided by Festo	
Programming language	To IEC 61131-3	
	Sequential function chart (SFC)	
	Instruction list (IL)	
	Function chart (FCH), additional continuous function chart (CFC)	
	Ladder diagram (LD)	
	Structured text (ST)	
Programming	Operating language	German, English
	Support for file handling	Yes
Device-specific diagnostics	Diagnostic memory	
	Channel and module-oriented diagnostics	
	Undervoltage/short-circuit modules	
LED displays	Bus-specific	TP: Link/traffic
	Product-specific	RUN: PLC status
		STOP: PLC status
		ERR: PLC runtime error
		PS: Electronics supply, sensor supply
		PL: Load supply
		SF: System fault
		M: Modify/forcing active
IP address setting	DHCP	
	Via CODESYS	
	Via MMI	
Function blocks	CPX diagnostic status, copy CPX diagnostic trace, read CPX module diagnostics, and more	
Dimensions (including interlinking block) W x L x H	[mm]	50 x 107 x 55

Materials		
Housing	Reinforced PA	
	PC	
Note on materials	RoHS-compliant	

Operating and environmental conditions		
Ambient temperature	[°C]	-5 ... +50
Storage temperature	[°C]	-20 ... +70
Relative humidity	[%]	95, non-condensing
Corrosion resistance class CRC ¹⁾		2

1) Corrosion resistance class CRC 2 to Festo standard FN 940070

Moderate corrosion stress. Indoor applications in which condensation can occur. External visible parts with primarily decorative surface requirements which are in direct contact with a normal industrial environment.

Electrical data		
Nominal operating voltage	[V DC]	24
Load voltage	Nominal operating voltage	[V DC] 24
	With pneumatics type VTSA	[V DC] 21.6 ... 26.4
	With pneumatics type MPA	[V DC] 18 ... 30
	Without pneumatics	[V DC] 18 ... 30
Mains buffering	[ms]	10
Intrinsic current consumption at nominal operating voltage	[mA]	Typically 85
Degree of protection to EN 60529		IP65, IP67

Data sheet

Technical data			CPX-CEC-C1	CPX-CEC-C1-V3
Type				
Additional functions			Motion functions for electric drives	Diagnostic functions RS232 communication function
CPU data	Flash	[MB]	32	32
	RAM	[MB]	32	32
	Processor	[MHz]	400	400
Control interface			CAN bus	–
Parameterisation			CODESYS V2.3	CODESYS V2.3
Configuration support			CODESYS V2.3	CODESYS V2.3
Program memory, user program		[MB]	4	4
Flags			CODESYS variable concept	
	Remnant data	[kB]	30	30
	Global data memory	[MB]	8	8
Control elements			DIL switch for CAN termination	–
			Rotary switch for RUN/STOP	Rotary switch for RUN/STOP
Total number of axes			31	127
Ethernet	Quantity		1	
	Connection technology		RJ45 socket, 8-pin	
	Data transmission speed	[Mbps]	10/100	
	Supported protocols		TCP/IP, EasyIP, Modbus TCP	
Fieldbus interface	Quantity		1	
	Connection technology		Sub-D plug, 9-pin	Sub-D socket, 9-pin
	Data transmission speed, can be set via software	[kbps]	125, 250, 500, 800, 1000	9.6 ... 230.4
	Supported protocols		CAN bus	RS 232 interface
	Galvanic isolation		Yes	Yes

Data sheet

Connection and display elements CPX-CEC-C1

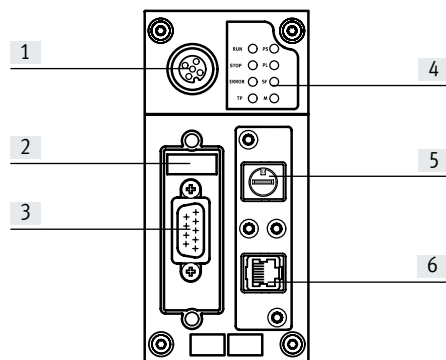

- [1] CPX-FMT connection
- [2] DIL switch
- [3] Fieldbus interface
(Sub-D plug, 9-pin)
- [4] Status LEDs, bus-specific and
product-specific
- [5] RUN/STOP rotary switch
- [6] Ethernet interface (RJ45 socket,
8-pin)

Pin allocation – CPX-CEC-C1

	Pin	Signal	Meaning
Fieldbus interface, Sub-D plug			
	1	n.c.	Not connected
	2	CAN_L	CAN low
	3	CAN_GND	CAN ground
	4	n.c.	Not connected
	5	CAN_SHLD	Connection to functional earth FE
	6	CAN_GND	CAN ground (optional) ¹⁾
	7	CAN_H	CAN high
	8	n.c.	Not connected
	9	n.c.	Not connected
Housing	Shielding	Plug housing must be connected to FE	
Ethernet interface, RJ45 plug			
	1	TD+	Transmitted data+
	2	TD-	Transmitted data-
	3	RD+	Received data+
	4	n.c.	Not connected
	5	n.c.	Not connected
	6	RD-	Received data-
	7	n.c.	Not connected
	8	n.c.	Not connected
Housing	Shielding	Shielding	

1) If a servo drive is connected to an external power supply, CAN ground (optional), pin 6, cannot be used on the CPX-CEC-C1/-M1.

Data sheet

Connection and display elements CPX-CEC

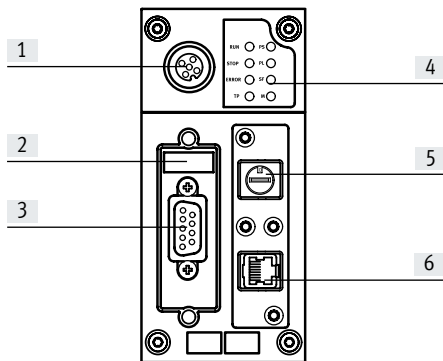







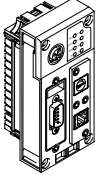
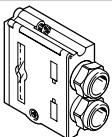

- [1] CPX-FMT connection
- [2] DIL switch
- [3] RS232 interface
(Sub-D socket, 9-pin)
- [4] Status LEDs, bus-specific and
product-specific
- [5] RUN/STOP rotary switch
- [6] Ethernet interface (RJ45 socket,
8-pin)

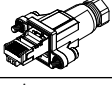

Pin allocation – CPX-CEC

	Pin	Signal	Meaning
RS 232 interface, Sub-D socket			
	1	n.c.	Not connected
	2	RxD	Received data
	3	TxD	Transmitted data
	4	n.c.	Not connected
	5	GND	Data reference potential
	6	n.c.	Not connected
	7	n.c.	Not connected
	8	n.c.	Not connected
	9	n.c.	Not connected
	Shielding	Shielding	Connection to functional earth
Ethernet interface, RJ45 plug			
	1	TD+	Transmitted data+
	2	TD-	Transmitted data-
	3	RD+	Received data+
	4	n.c.	Not connected
	5	n.c.	Not connected
	6	RD-	Received data-
	7	n.c.	Not connected
	8	n.c.	Not connected
	Housing	Shielding	Shielding

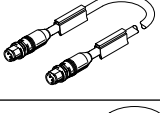
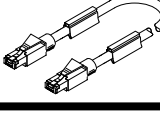
Accessories

Ordering data				Part no.	Type	
Designation						
Control block						
	Motion functions for electric drives			567347	CPX-CEC-C1	
	RS232 communication function			567346	CPX-CEC	
Fieldbus interface						
	Sub-D plug, 9-pin, for CANopen			532219	FBS-SUB-9-BU-2x5POL-B	
	Micro style bus connection, 2xM12 for DeviceNet/CANopen			525632	FBA-2-M12-5POL	
	Socket for micro style connection, M12			18324	FBSD-GD-9-5POL	
	Plug for micro style connection, M12			175380	FBS-M12-5GS-PG9	
	Open style bus connection for 5-pin terminal strip for DeviceNet/CANopen			525634	FBA-1-SL-5POL	
	Terminal strip for open style connection, 5-pin			525635	FBSD-KL-2x5POL	
Ethernet interface						
	RJ45 plug	Degree of protection IP 65, IP67		534494	FBS-RJ45-8-GS	
	Cover for RJ45 connection	Degree of protection IP 65, IP67		534496	AK-RJ45	
	Straight plug, RJ45, 8-pin	Straight plug, M12x1, 4-pin, D-coded	Degree of protection IP20	1 m	8040451	NEBC-D12G4-ES-1-S-R3G4-ET
				3 m	8040452	NEBC-D12G4-ES-3-S-R3G4-ET
				5 m	8040453	NEBC-D12G4-ES-5-S-R3G4-ET
				10 m	8040454	NEBC-D12G4-ES-10-S-R3G4-ET
	Straight plug, RJ45, 8-pin	Straight plug, RJ45, 8-pin	Degree of protection IP20	1 m	8040455	NEBC-R3G4-ES-1-S-R3G4-ET

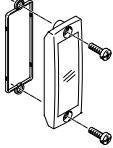
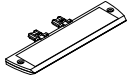
Accessories

Ordering data		Part no.	Type
Designation			
Coverings and attachments			
	Inspection cover, transparent, for Sub-D connection	533334	AK-SUB-9/15-B
	Inscription label holder for manifold block	536593	CPX-ST-1
User documentation			
	Manual for control block CPX-CEC	German	569121 P.BE-CPX-CEC-DE
		English	569122 P.BE-CPX-CEC-EN