

Stopper cylinders DFST-G2

FESTO



Characteristics

At a glance

- With cushioning for heavy and delicate loads
Size 32: Workpieces up to 40 kg
Size 50 ... 80: Workpieces up to 800 kg
- Flexible range of applications owing to adjustable shock absorber
- Gentle stopping without impact vibration or noise
- Double- or single-acting function
- Sturdy design for long service life

Illustration for size 32

Simple shock absorber adjustment using a scale

Cushioning characteristic can be adjusted by simply rotating the shock absorber.

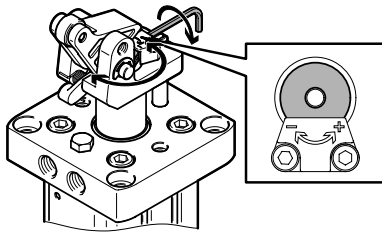

Optional: Lever locking mechanism

Fixes the toggle lever in the end position after the stop process, preventing the spring force of the shock absorber from pushing the transported goods backwards.

Application: Specific position, e.g. for an indexing process.

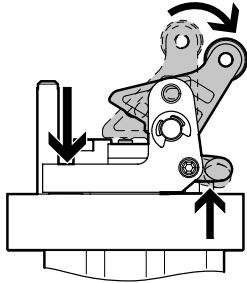

Roller material

Material can be selected from polymer or steel.

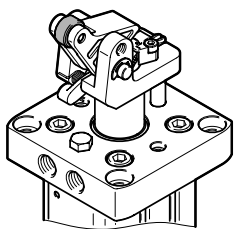

Simple replacement of the shock absorber

To replace the shock absorber all that is required is to undo three screws and remove the stop.

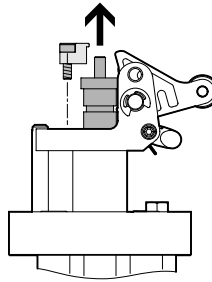

Optional: Lever deactivating mechanism

Deactivates the toggle lever by putting the cap on. This allows the pallets to pass through.

Application: Convenient alternative to holding the stopper in the lower end position, e.g. during the installation process.

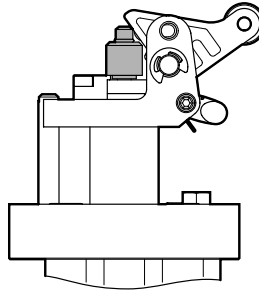

Adjustable effective direction (90°, 180°, 270°)

For aligning the toggle lever in relation to the supply ports.

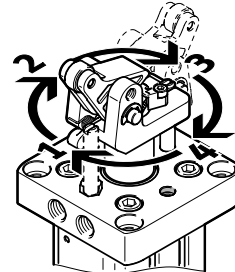

Key features

Illustration for size 50 ... 80

Simple shock absorber adjustment using a scale

Cushioning characteristic can be adjusted by simply rotating the shock absorber. The new visualisation of the cushioning adjustment makes it easier e.g. to commission multiple stopper cylinders.

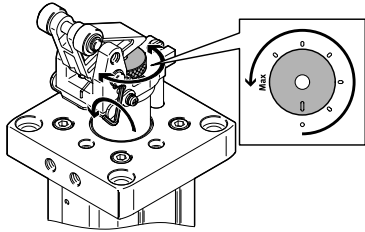

Optional: Lever locking mechanism

Fixes the toggle lever in the end position after the stop process, preventing the spring force of the shock absorber from pushing the transported goods backwards.

Application: Specific position, e.g. for an indexing process.

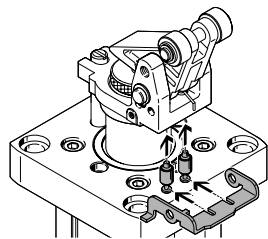
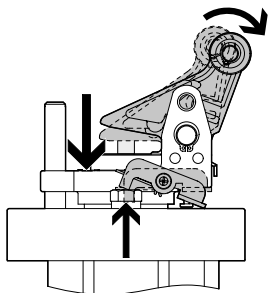

Note:

Two pins are included in the scope of delivery of the DFST-...-L. One pin is for the lever locking mechanism and the other for the lever deactivating mechanism. The pin for the lever locking mechanism is fitted prior to delivery.

Roller material

Material can be selected from polymer or steel.

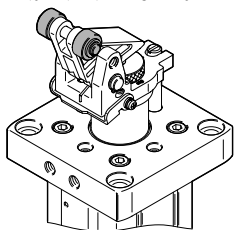

Simple replacement of the shock absorber

All that is required to replace the shock absorber is to undo a lock bolt.

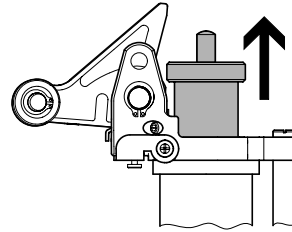

Optional: Lever deactivating mechanism

Deactivates the toggle lever by manually pressing down the toggle lever so that pallets can pass through. New: Automatic release of the toggle lever as the piston rod is retracted.

Application: Convenient alternative to holding the stopper in the lower end position, e.g. during the installation process.

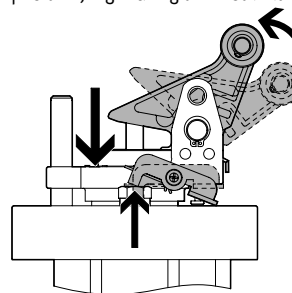

Adjustable effective direction (90°, 180°, 270°)

For aligning the toggle lever in relation to the supply ports.

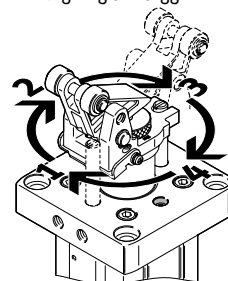

Characteristics

At a glance

Supply port
At the side

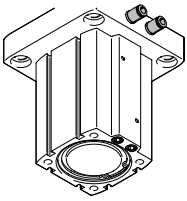

Underneath

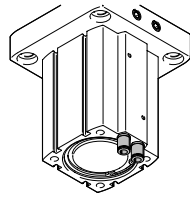

Versatile position sensing
Toggle lever

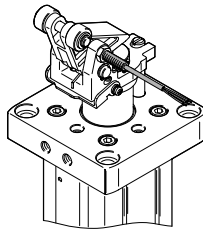

Piston position

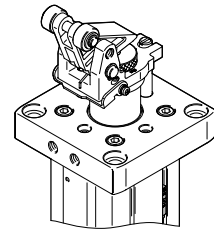

Functional sequence

Step 1

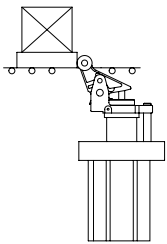

Gentle braking of heavy loads via a hydraulic shock absorber in the piston rod.

Step 2

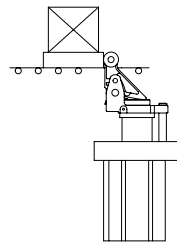

Toggle lever reaches the retracted end position. Optionally with lever locking mechanism: the load cannot be pushed back by the shock absorber.

Step 3

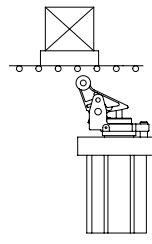

The load is released by means of compressed air, and the toggle lever is unlocked simultaneously.

Step 4

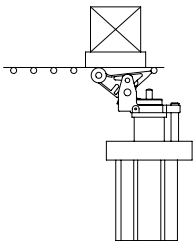

The piston is extended by means of spring force or compressed air. The toggle lever tips back which prevents the load from being lifted.

Step 5

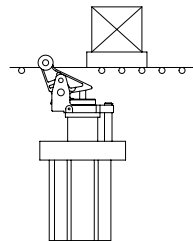

The toggle lever is raised by means of spring force and can stop the next load.

Type codes

001	Series
DFST	Stopper cylinder

002	Piston diameter [mm]
32	32
50	50
63	63
80	80

003	Stroke [mm]
20	20
30	30
40	40

004	Function
	Double-acting with spring
D	Double-acting

005	Interlock
	None
L	With toggle lever locking mechanism

006	Cushioning
Y4	Shock absorber, adjustable, at front

007	Position sensing
A	For proximity sensor

008	Rollers
	POM
S	Steel

009	Generation
G2	2nd generation

 **Note**

The double-acting DFST with spring variant can also be used as a single-acting drive.

Peripherals overview

Peripherals overview

Size 32

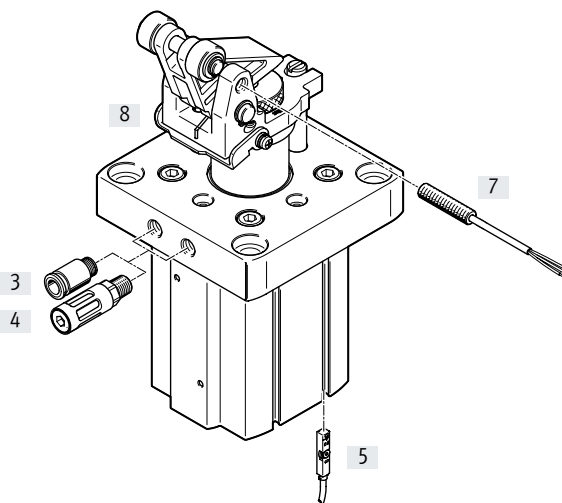
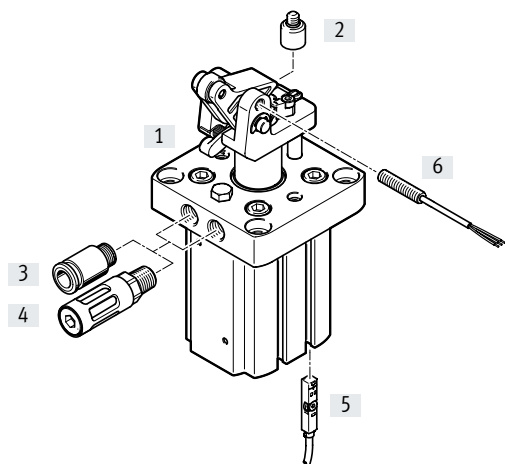

Size 50 ... 80

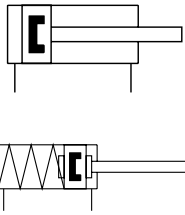

Accessories			
Type	For ø	Description	→ Page/Internet
[1] Lever locking mechanism	32	<ul style="list-style-type: none"> For fixing the toggle lever in the retracted end position Included in the scope of delivery of variant DFST-...-L 	16
[2] Lever deactivating mechanism	32	<ul style="list-style-type: none"> For deactivating the toggle lever Not included in the scope of delivery of the stopper cylinder 	16
[3] Push-in fitting QS	32 ... 80	For connecting tubing with standard O.D.	qs
[4] Silencer	32 ... 80	For noise reduction at the exhaust port. Only in combination as a single-acting function	silencer
[5] Proximity switches SME-/SMT-8	32 ... 80	For sensing the piston position	16
[6] Proximity switches SIEN-M5	32	For sensing the toggle lever position	17
[7] Proximity switches SIEN-M8	50 ... 80	For sensing the toggle lever position	17
[8] Toggle lever function selection kit	50 ... 80	<ul style="list-style-type: none"> For fixing the toggle lever in the retracted end position or deactivating the toggle lever. The load is released and the toggle lever unlocked simultaneously on pressurisation Included in the scope of delivery of variant DFST-...-L 	16

Data sheet



-  - Diameter
50 ... 80 mm
-  - Stroke length
30 ... 40 mm



General technical data					
Piston diameter		32	50	63	80
Pneumatic connection		G1/8			
Stroke	[mm]	20	30	30	40
Design		Piston rod with toggle lever			
Mode of operation		Double-acting			
		Double-acting with spring			
Protection against rotation/guide		Guide rod			
Type of mounting		With through-hole			
Cushioning		Elastic cushioning rings/plates at both ends (for piston rod movement)			
		Adjustable shock absorber			
Cushioning length	[mm]	14	15	15	20
Position sensing		Via proximity switch			
Toggle lever position sensing		For inductive sensors			
Mounting position		Vertical			
Product weight	[g]	750	1900	3400	6350

Operating and environmental conditions	
Operating medium	Compressed air to ISO 8573-1:2010 [7:-:-]
Operating pressure	[bar] 2 ... 10
Ambient temperature	[°C] 5 ... 60
Corrosion resistance CRC ¹⁾	1

1) Corrosion resistance class CRC 1 to Festo standard FN 940070
Low corrosion stress. Dry internal application or transport and storage protection. Also applies to parts behind covers, in the non-visible interior area, and parts which are covered in the application (e.g. drive trunnions).

Materials

Sectional view

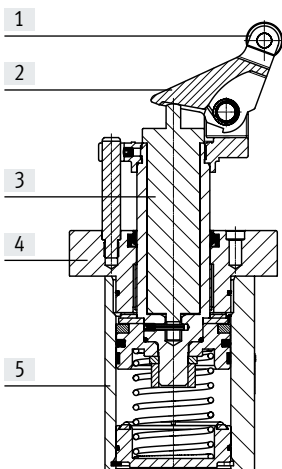

Piston diameter		50	63	80
[1]	Rollers			
	[]	POM		
	[S]	Steel		
[2]	Top elements	Nickel-plated steel casting		
[3]	Piston rod	High-alloy stainless steel		
[4]	Cover	Die-cast aluminium	Aluminium	
[5]	Housing	Wrought aluminium alloy		
-	Seals	NBR		
	Note on materials	Contains paint-wetting impairment substances		
		RoHS-compliant		

Data sheet

Braking distance

The braking distance s refers to the distance from when contact is made with the toggle lever to the end stop.

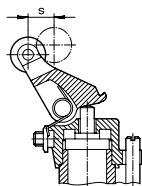

Piston diameter		32	50	63	80
Braking distance	[mm]	14	15	15	20

Resetting force F_R of the toggle lever against the delivery direction

The resetting force refers to the minimum force that must be applied to press the toggle lever into the end position.

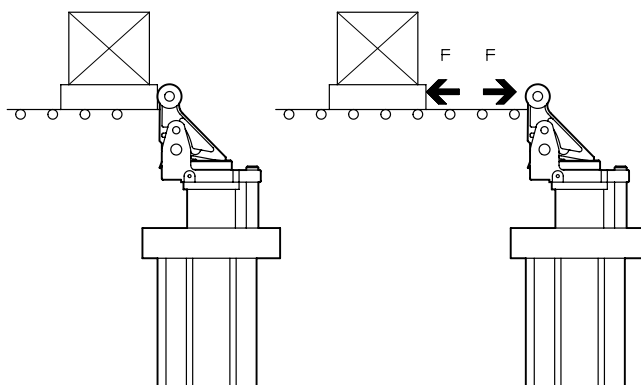

Piston diameter		32	50	63	80
Resetting force at the toggle lever	[N]	4	22	23	36

Permissible impact force F_S on the rollers of the toggle lever with piston rod advanced and toggle lever pushed into the end position

The permissible impact force refers to the momentary force that can act on the toggle lever when it is already pushed into its end position without damaging the rod bearing or the toggle lever mechanism.

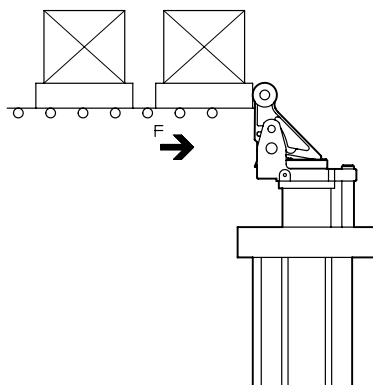

Piston diameter		32	50	63	80
Impact force	[N]	1000	3000	5000	6000

Data sheet

Permissible load m as a function of conveyor speed v

A coefficient of friction of $\mu = 0.1$ has been taken into consideration in the values.

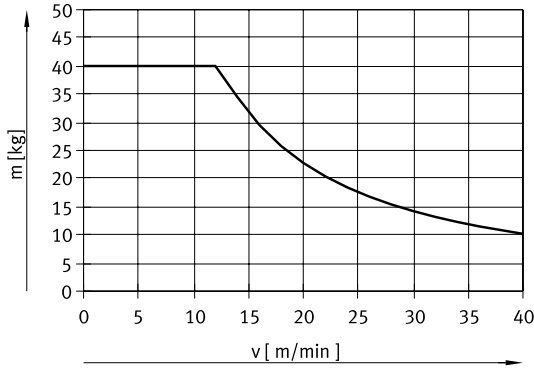

— ø 32

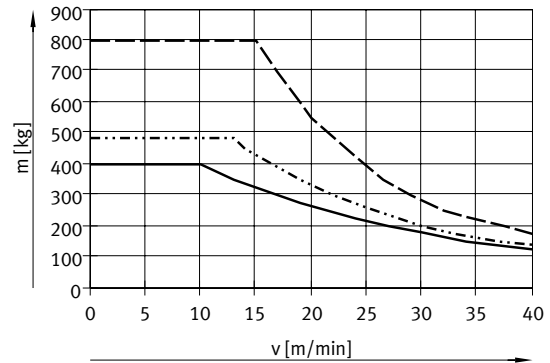

— ø 50
 - · - · ø 63
 - - - ø 80

Permissible lateral force F_Q during the switching operation as a function of the pressure p

The applied load causes a lateral force on the piston rod. A certain minimum pressure must be applied in order to guarantee the cylinder function.

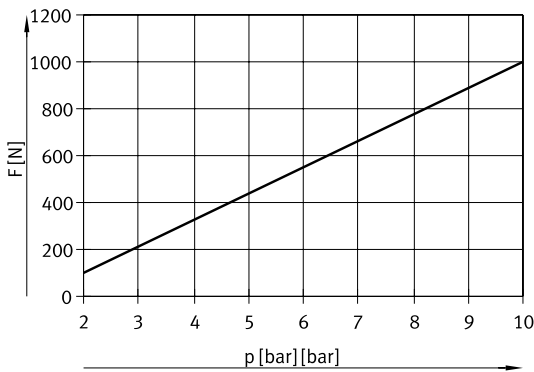

— ø 32

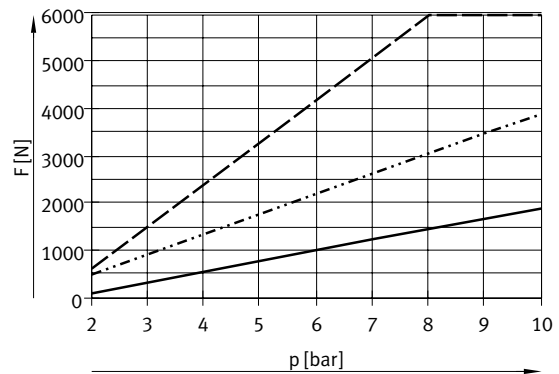

— ø 50
 - · - · ø 63
 - - - ø 80

Data sheet

Selection aid

Stopping a pallet

The stopper cylinder is used to stop an individual workpiece carrier, with or without end-position locking. Toggle lever and shock absorber are pushed into their end position again for each pallet.

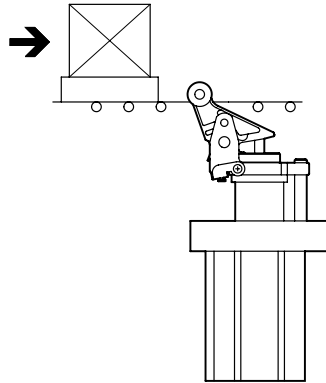

Example

Given:
 Friction factor $\mu = 0.1$
 Conveying speed $v = 20 \text{ m/min}$
 Pallet with workpiece $m = 200 \text{ kg}$
 Operating pressure $p = 6 \text{ bar}$

Selection: Stopper cylinder DFST-50

1. Checking the permissible load

The maximum permissible load at a conveying speed of 20 m/min is 250 kg. This means that the total load of 200 kg for the pallet and the workpiece is permissible.

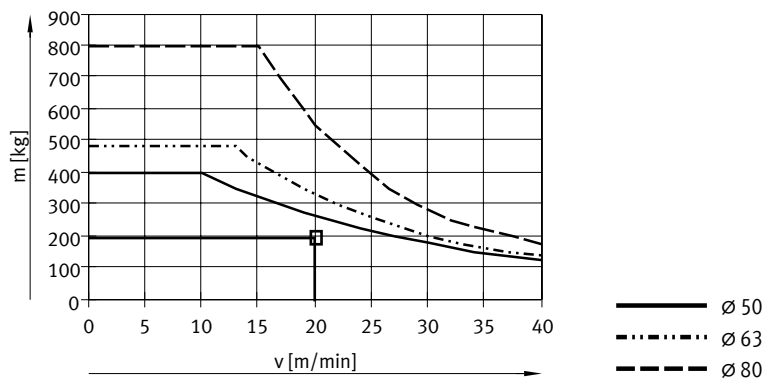

2. Checking the permissible lateral force during the switching operation

Lateral force $F_Q =$ Frictional force F_R
 $F_R = \mu \times m \times g$
 $= 0.1 \times 200 \text{ kg} \times 9.81 \text{ m/s}^2$
 $= \text{approx. } 200 \text{ N}$

The maximum permissible lateral force at an operating pressure of 6 bar is 1000 N.

This means that the lateral force of 200 N is permissible.

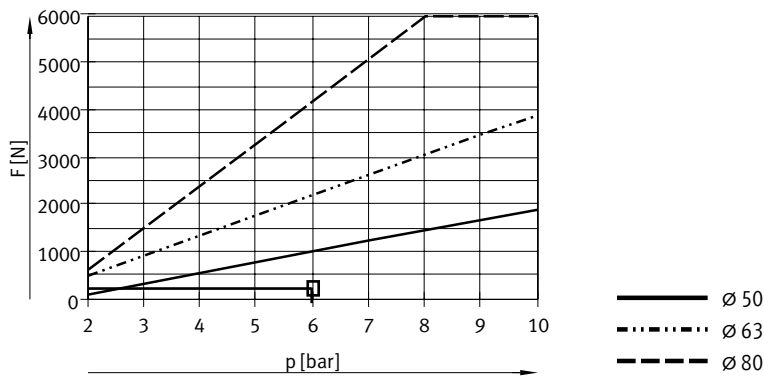

Data sheet

Selection aid

Stopping or separating several pallets

The stopper cylinder is used to separate pallets. Further pallets collide with the pallets that have already pushed the toggle lever into its end position. Since the shock absorber in the stopper cylinder does not function in this case, a certain amount of buffering between the pallets must be ensured (e.g. by using elastomer elements).

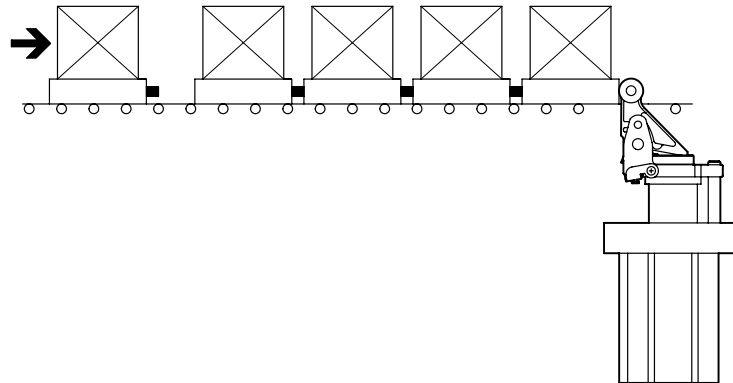

Example

Given:

Friction factor $\mu = 0.1$ Conveying speed $v = 15 \text{ m/min}$ Pallet with workpiece $m = 100 \text{ kg}$ Operating pressure $p = 6 \text{ bar}$ Maximum number of pallets arriving simultaneously $n_G = 1$ Maximum number of all queued pallets $n_A = 5$ Maximum number of all advancing pallets $n_{A-1} = 4$ Spring travel of the pallet buffer $s_F = 10 \text{ mm}$

Selection: Stopper cylinder DFST-50

1. Checking the permissible load of the first pallet

The maximum permissible load at a conveying speed of 15 m/min is 320 kg . This means that a total load of 100 kg for the pallet and the workpiece is permissible.

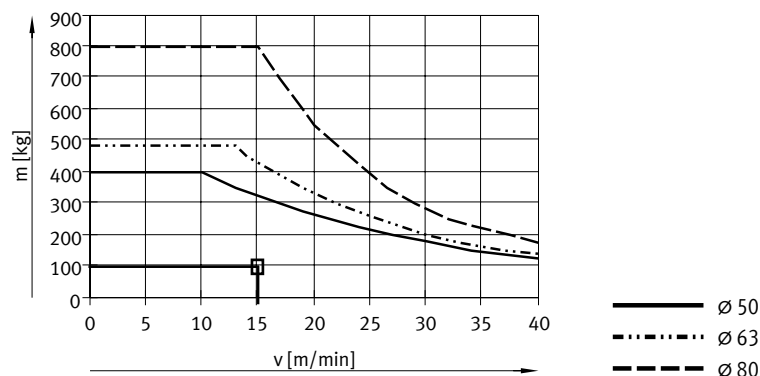

2a. Calculation of the maximum permissible impact force when pallets collide with a pallet resting against the stopper cylinder

The maximum permissible impact force with the DFST-50 is 3000 N . This means that, with a total force of 1150 N , the number of pallets as per the above example is permissible.

$$F_S = \frac{(n_G \times m) \times v^2}{s_F} = \frac{(1 \times 100 \text{ kg}) \times (15 \text{ m} / 60 \text{ s})^2}{0,01 \text{ m}} = \text{ca. } 650 \text{ N}$$

Impact force calculation:

$$\text{Friction force: } F_R = \mu \times (n_A \times m) \times g = 0.1 \times (5 \times 100 \text{ kg}) \times 9.81 \text{ m/s}^2 = \text{approx. } 500 \text{ N}$$

$$\text{Max. total force: } F_{\text{ges}} = F_S + F_R = 650 \text{ N} + 500 \text{ N} = 1150 \text{ N}$$

Data sheet

Selection aid

2b. Checking the permissible lateral force during the switching operation

Lateral force $F_Q =$ Frictional force F_R
 $F_R = 500 \text{ N}$

The maximum permissible lateral force at an operating pressure of 6 bar is 1000 N.
 This means that a lateral force of 500 N is permissible.

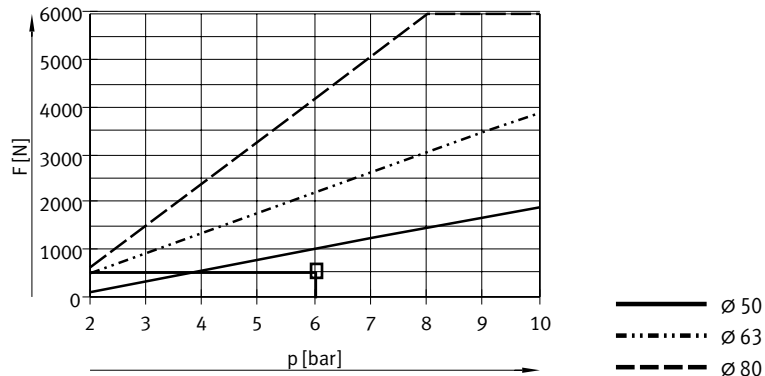

3. Separating and advancing the pallets

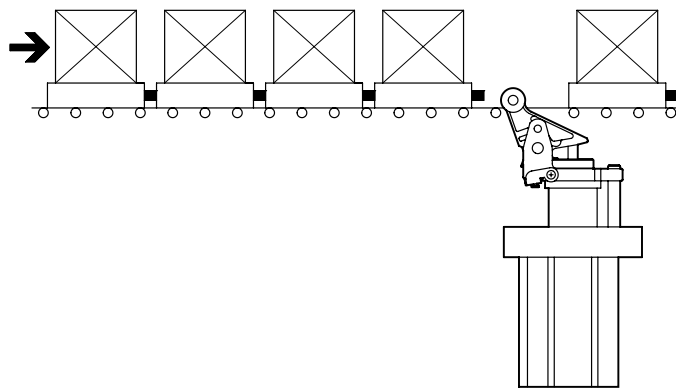

The maximum permissible load with the DFST-50 at a conveying speed of 15 m/min is 320 kg. Since the total load of the 4 pallets advancing on the stopper cylinder is 400 kg, the next size stopper cylinder must be selected for separating.

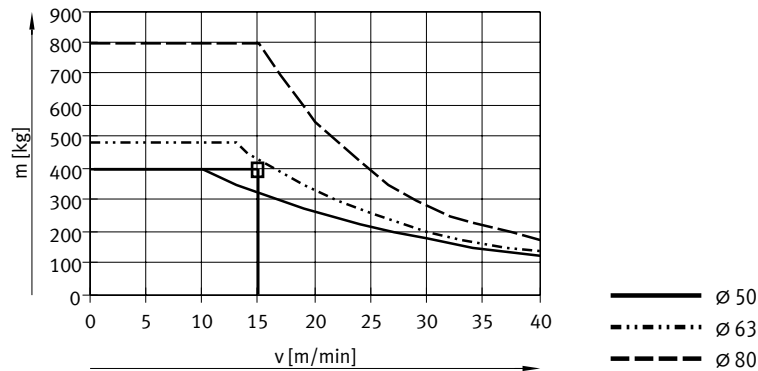

Max. total load:
 $m_G = n_{A-1} \times m = 4 \times 100 \text{ kg} = 400 \text{ kg}$

Result

To separate 5 pallets, the stopper cylinder DFST-63 must be selected.

Data sheet

Dimensions

Download CAD data → www.festo.com

Size 32

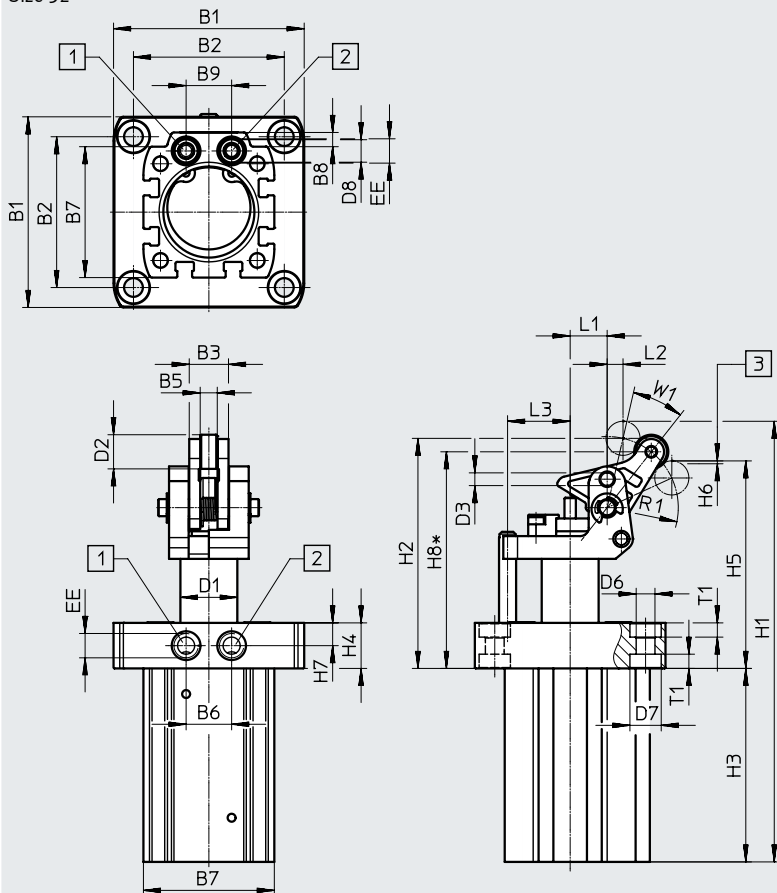

- [1] Supply port, retracting
- [2] Supply port, advancing
- [3] Lowest permissible pallet underside

∅ [mm]	B1	B2	B3	B5	B6	B7	B8	B9	D1	D2
32	67	53	13.8	6	16	46	5	16	∅ 20	∅ 12
∅ [mm]	D3	D6	D7	D8	EE	H1	H2	H3	H4	H5
32	M5x0.5	∅ 6.6	∅ 11	∅ 7.9	G1/8	155.3	81.3	68	16	73.8
∅ [mm]	H6	H7	H8	L1	L2	L3	R1	T1	W1	
32	1	8	76.1	13	3	22	25	5	31.4	

Data sheet

Dimensions

Download CAD data → www.festo.com

Size: 50 ... 80

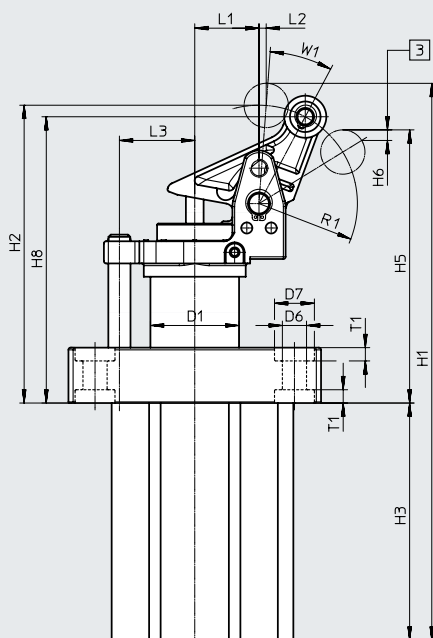
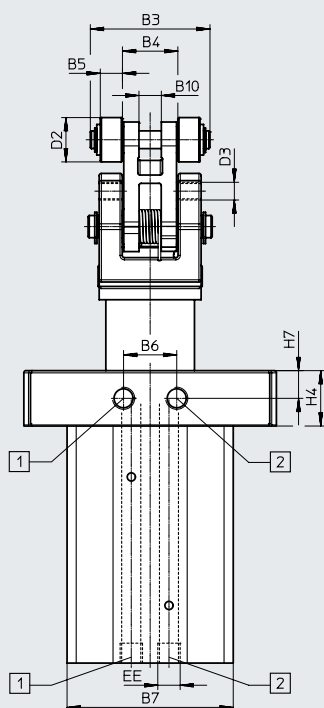
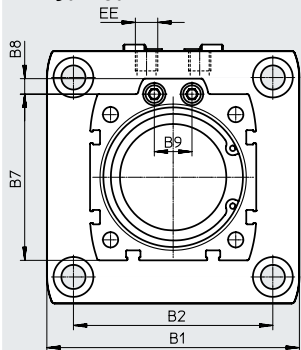

- [1] Supply port, retracting
- [2] Supply port, advancing
- [3] Lowest permissible pallet underside

∅ [mm]	B1	B2	B3	B4	B5	B6	B7	B8	B9	B10
50	93	73	43	20	8	17	64	7	17	8.1
63	114	90	54	25	10	24	75	7	17	10.1
80	138	110	63	30	12	24	95	7	17	12.1



∅ [mm]	D1	D2	D3	D6	D7	EE	H1	H2	H3	H4
	∅	∅								
50	32	20	M8x1	9	14	G1/8	218.8	117.8	91	17.5
63	40	20	M8x1	11	18	G1/8	251	134	107	25
80	50	25	M8x1	13	20	G1/8	322.5	159	151	19

∅ [mm]	H5	H6	H7	H8	L1	L2	L3	R1	T1	W1
50	106.8	2.76	8.75	112.1	23	6.3	26	38.5	5	23.5
63	123.5	6.23	12.5	129.5	29	6	34	44.4	6	20.3
80	143.8	4.31	9.5	152.2	36	8	42	55.6	6	23.5

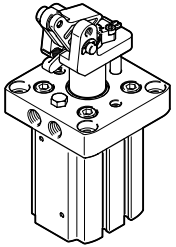
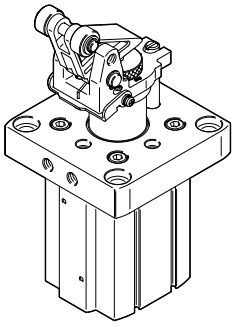

Data sheet

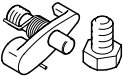
Ordering data	Piston diameter	Roller made from steel	With spring	With lever locking mechanism	Part no.	Type		
	32		■		8093003	DFST-32-20-Y4-A-G2		
			■	■	8093004	DFST-32-20-L-Y4-A-G2		
					■	8093005	DFST-32-20-D-Y4-A-G2	
					■	8093006	DFST-32-20-DL-Y4-A-G2	
		■	■		■	8093007	DFST-32-20-Y4-S-A-G2	
		■	■	■	■	8093008	DFST-32-20-L-Y4-S-A-G2	
		■			■	8093009	DFST-32-20-D-Y4-S-A-G2	
		■			■	8093010	DFST-32-20-DL-Y4-S-A-G2	
	50		■		8090405	DFST-50-30-Y4-A-G2		
			■	■	8090406	DFST-50-30-L-Y4-A-G2		
					■	8090407	DFST-50-30-D-Y4-A-G2	
					■	8090408	DFST-50-30-DL-Y4-A-G2	
		■	■		■	8090409	DFST-50-30-Y4-A-S-G2	
		■	■	■	■	8090410	DFST-50-30-L-Y4-A-S-G2	
		■			■	8090411	DFST-50-30-D-Y4-A-S-G2	
		■			■	8090412	DFST-50-30-DL-Y4-A-S-G2	
		63		■		■	8085906	DFST-63-30-Y4-A-G2
				■	■	■	8085907	DFST-63-30-L-Y4-A-G2
				■	8085908	DFST-63-30-D-Y4-A-G2		
				■	8085909	DFST-63-30-DL-Y4-A-G2		
■	■			■	8085910	DFST-63-30-Y4-A-S-G2		
■	■		■	■	8085911	DFST-63-30-L-Y4-A-S-G2		
■				■	8085912	DFST-63-30-D-Y4-A-S-G2		
80			■		■	8085913	DFST-63-30-DL-Y4-A-S-G2	
			■		■	8089685	DFST-80-40-Y4-A-G2	
			■	■	■	8089686	DFST-80-40-L-Y4-A-G2	
					■	8089687	DFST-80-40-D-Y4-A-G2	
				■	■	8089688	DFST-80-40-DL-Y4-A-G2	
	■	■		■	■	8089689	DFST-80-40-Y4-A-S-G2	
	■	■	■	■	■	8089690	DFST-80-40-L-Y4-A-S-G2	
	■			■	■	8089691	DFST-80-40-D-Y4-A-S-G2	
			■	■	8089692	DFST-80-40-DL-Y4-A-S-G2		

Accessories

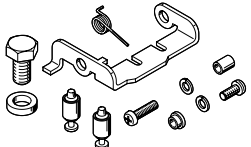

Ordering data		For ø	Part no.	Type
Lever locking mechanism				
		32	8097332	DADP-TL-F3-32
Lever deactivating mechanism				
		32	8097333	DADP-TF-F3-32



Ordering data – Toggle lever function selection kit		For ø	Part no.	Type
		50	8093804	DADP-TU-F3-50
		63	8093805	DADP-TU-F3-63
		80	8093806	DADP-TU-F3-80

Ordering data – Proximity switch for T-slot, magneto-resistive						Data sheets → Internet: smt
	Type of mounting	Switching output	Electrical connection	Cable length [m]	Part no.	Type
N/O contact						
	Inserted in the slot from above, flush with the cylinder profile, short design	PNP	Cable, 3-wire	2.5	574335	SMT-8M-A-PS-24V-E-2,5-OE
			Plug M8x1, 3-pin	0.3	574334	SMT-8M-A-PS-24V-E-0,3-M8D
			Plug M12x1, 3-pin	0.3	574337	SMT-8M-A-PS-24V-E-0,3-M12
		NPN	Cable, 3-wire	2.5	574338	SMT-8M-A-NS-24V-E-2,5-OE
			Plug M8x1, 3-pin	0.3	574339	SMT-8M-A-NS-24V-E-0,3-M8D
N/C contact						
	Inserted in the slot from above, flush with the cylinder profile, short design	PNP	Cable, 3-wire	7.5	574340	SMT-8M-A-PO-24V-E-7,5-OE

Ordering data – Proximity switches for T-slot, magnetic reed						Data sheets → Internet: sme
	Type of mounting	Switching output	Electrical connection	Cable length [m]	Part no.	Type
N/O contact						
	Inserted in the slot from above, flush with the cylinder profile	Contacting	Cable, 3-wire	2.5	543862	SME-8M-DS-24V-K-2,5-OE
				5.0	543863	SME-8M-DS-24V-K-5,0-OE
			Cable, 2-wire	2.5	543872	SME-8M-ZS-24V-K-2,5-OE
			Plug M8x1, 3-pin	0.3	543861	SME-8M-DS-24V-K-0,3-M8D

Accessories

Ordering data – Proximity switch, inductive						Data sheets → Internet: sien
	For ø	Thread	Contact	Connection	Part no.	Type
	32	M5	N/O contact	Cable, 2.5 m	150370	SIEN-M5B-PS-K-L
				Plug	150371	SIEN-M5B-PS-S-L
			N/C contact	Cable, 2.5 m	150374	SIEN-M5B-PO-K-L
				Plug	150375	SIEN-M5B-PO-S-L
	50 ... 80	M8	N/O contact	Cable, 2.5 m	150386	SIEN-M8B-PS-K-L
				Plug	150387	SIEN-M8B-PS-S-L
			N/C contact	Cable, 2.5 m	150390	SIEN-M8B-PO-K-L
				Plug	150391	SIEN-M8B-PO-S-L

Ordering data – Connecting cables					Data sheets → Internet: nebu
	Electrical connection, left	Electrical connection, right	Cable length [m]	Part no.	Type
	Straight socket, M8x1, 3-pin	Cable, open end, 3-wire	2.5	541333	NEBU-M8G3-K-2.5-LE3
			5	541334	NEBU-M8G3-K-5-LE3
	Straight socket, M12x1, 5-pin		2.5	541363	NEBU-M12G5-K-2.5-LE3
			5	541364	NEBU-M12G5-K-5-LE3
	Angled socket, M8x1, 3-pin	Cable, open end, 3-wire	2.5	541338	NEBU-M8W3-K-2.5-LE3
			5	541341	NEBU-M8W3-K-5-LE3
	Angled socket, M12x1, 5-pin		2.5	541367	NEBU-M12W5-K-2.5-LE3
			5	541370	NEBU-M12W5-K-5-LE3