

## SHZ

Air Gripper

SHZ:  
Standard double acting



SHZSA:  
Single acting (N.O.)

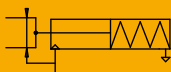

SHZSB:  
Single acting (N.C.)

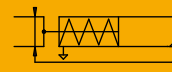

### Specifications

Bore size(mm)		10	16	20	25
Acting type		Double Acting/Single Acting			
Working medium		Clean Air(40 μ m filtration)			
Applicable pressure range	Double acting	Φ 10	0.15~0.7MPa(22~100psi)(1.5~7.0bar)		
		Φ 16~Φ 25	0.1~0.7MPa(15~100psi)(1.0~7.0bar)		
	Single acting	Φ 10	0.3~0.7MPa(45~100psi)(3.0~7.0bar)		
		Φ 16~Φ 25	0.25~0.7MPa(36~100psi)(2.5~7.0bar)		
Working temperature		-20~80°C(No freezing)			
Oil		Not required			
Maximum frequency		180(C.P.M)			
Port size		M3X0.5	M5X0.8		
Weight(g)		52	120	236	430

### How to Order?

Series	Type No.	Bore	Magnet No.
SHZ: Parallel air gripper	Blank: Basic type SA: Single acting (N.O.) SB: Single acting (N.C.)	10 16 20 25	S: With magnet (Magnet is standard)

Order Example:

Parallel air gripper, Bore 20, with magnet, ERP code is: SHZ20-S

### Product Features

1. Integrated design of linear guide rail, high rigidity, high precision;
2. Positioning pin at the bottom of the linear guide rail, efficiently preventing deviation of guide rail from the body;
3. Deeper attached fixing benchmark centering hole, improving fixing accuracy, and improving consistency after repeated dismounting and fixing
4. According to the actual requirements of the customer, the initial position of the claw can be customized to meet the different needs under different working conditions.

3

SHZ

### Optional Acces

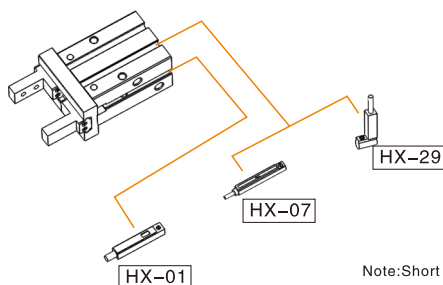

Note: Short stroke please use HX-29 series due to limited space.

### Clamping Force and Stroke

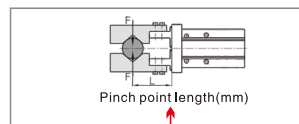

Acting Type	Type	Clamping force effective value of single air finger(N)		Stroke(two sides) (L) ( mm )	
		Closure clamping torque	Open clamping torque		
Double acting	SHZ10	11	17	4	
	SHZ16	34	45	6	
	SHZ20	45	68	10	
	SHZ25	69	102	14	
Single acting (N.O.)	(N.O.)	SHZSA10	7	-	4
		SHZSA16	27	-	6
		SHZSA20	35	-	10
		SHZSA25	55	-	14
	(N.C.)	SHZSB10	-	13	4
		SHZSB16	-	38	6
		SHZSB20	-	59	10
		SHZSB25	-	87	14

Note: The value of the clamping force in above table is when the working pressure is 0.5Mpa and the L value of the clamping point is 20mm.

## Internal Structure

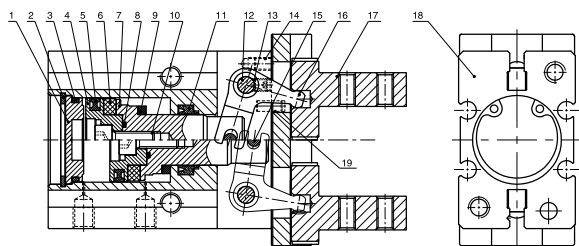

No.	Part Name	Material	No.	Part Name	Material
1	Rear cover	Aluminum alloy	11	Piston rod seal	TPU/NBR(φ25)
2	C type retainer ring	Spring steel	12	Pin	Stainless steel
3	O-ring	NBR	13	Hexagon set screw	Carbon steel
4	Piston	Aluminum alloy/ Stainless steel (φ10)	14	Hexagon socket cap screw	Carbon steel
5	Piston seal	NBR	15	Pin	Stainless steel
6	Magnet	Plastic	16	Bent lever	Alloy steel
7	Piston rod	Aluminum alloy/ Stainless steel (φ10, φ16)	17	Clamping jaw assembly	Assembly
8	O-ring	NBR	18	Barrel	Aluminum alloy
9	Anti-bump cushion	PTEE	19	Pin	Stainless steel
10	Hexagon socket cap screw	Carbon steel			

## Main Dimension

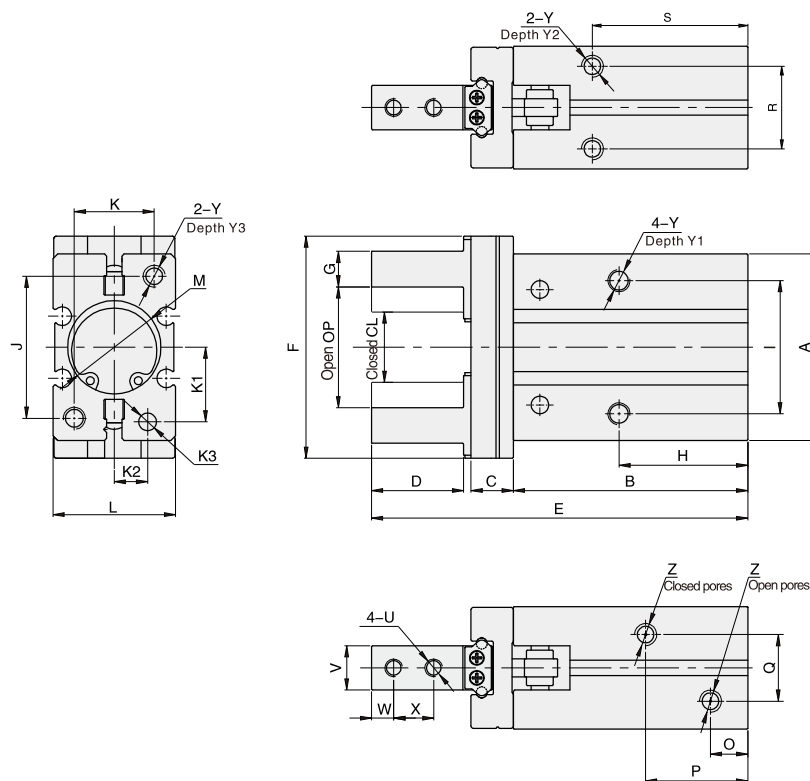

Bore/Sign	A	B	C	D	E	F	G	H	I	J	K	L	M	O	P	Q	K1	K2	K3
SHZ10	23	37.6	6	12.3	57	29	4 <sup>0</sup> <sub>-0.05</sub>	23	16	18	12	16.4	11 <sup>+0.05</sup> <sub>0</sub> Depth2	7	18.8	10	7.6	5.2	2 <sup>+0.05</sup> <sub>0</sub> Depth3
SHZ16	30.6	42.5	7.5	15.5	67.3	38	5 <sup>0</sup> <sub>-0.05</sub>	24.5	24	22	15	23.6	17 <sup>+0.05</sup> <sub>0</sub> Depth2	7.1	18.5	13	11	6.5	3 <sup>+0.05</sup> <sub>0</sub> Depth3
SHZ20	42	52.8	9.5	20.7	84.7	50	8 <sup>0</sup> <sub>-0.05</sub>	29	30	32	18	27.6	21 <sup>+0.05</sup> <sub>0</sub> Depth3	8.4	23	15	16.8	7.5	4 <sup>+0.05</sup> <sub>0</sub> Depth4
SHZ25	52	63.6	11	25.5	102.7	63	10 <sup>0</sup> <sub>-0.05</sub>	30	36	40	22	33.6	26 <sup>+0.05</sup> <sub>0</sub> Depth3.5	9.5	23.5	19.5	21.8	10	4 <sup>+0.05</sup> <sub>0</sub> Depth4
Bore/Sign	R	S	U	W	V	X	Y	Y1	Y2	Y3	Z	OP	CL						
SHZ10	11.4	27	M2.5X0.45	3	5 <sup>0</sup> <sub>-0.05</sub>	5.7	M3X0.5	6	6	6	M3X0.5	14.8 <sup>+2</sup> <sub>0</sub>	11.4 <sup>0</sup> <sub>0.7</sub>						
SHZ16	16	30	M3X0.5	4	8 <sup>0</sup> <sub>-0.05</sub>	7	M4X0.7	9.5	5.5	8	M5X0.8	20.8 <sup>+2</sup> <sub>0</sub>	14.8 <sup>0</sup> <sub>0.7</sub>						
SHZ20	18.6	35	M4X0.7	5	10 <sup>0</sup> <sub>-0.05</sub>	9	M5X0.8	11.5	8	10	M5X0.8	26 <sup>+2</sup> <sub>0</sub>	16.2 <sup>0</sup> <sub>0.7</sub>						
SHZ25	22	36.5	M5X0.8	6	12 <sup>0</sup> <sub>-0.05</sub>	12	M6X1.0	14.5	10	12	M5X0.8	33.5 <sup>+2</sup> <sub>0</sub>	19.2 <sup>0</sup> <sub>0.7</sub>						

## Installation and Use

1. Installing a fall prevention device is recommended when applying a lowering clamping force. In the case of a sudden pressure decrease due to emergency stop, these prevention devices can help to avoid personal or equipment injuries.
2. Don't use air gripper upon strong external force and impact force. Air grippers are not intended for use under external or impact forces.
3. When installing or repairing your air gripper take precautions to safely use your component.
4. Please contact with us when using the single acting type gripper for specific spring action force information.
5. Don't reverse the clamping gripper when installing clamping parts.
6. The locking torque of the fastening screw must be within the prescribed torque range shown in the chart below. If the locking torque is not set properly the unit will not perform correctly.

### Tail Mounting Type

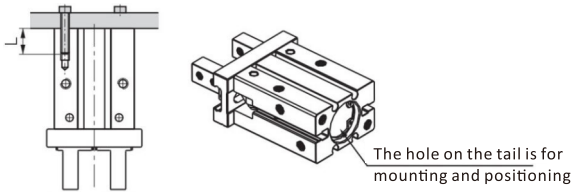

Bore	Bolt Size	Max.Locking Torque (Nm)	Max.Screwed Depth (mm)	Tail Positioning Bore Dia(mm)	Tail positioning Depth(mm)
10	M3X0.5	0.88	6	$\phi 11_{-0.05}^{+0.05}$	2
16	M4X0.7	2.1	8	$\phi 17_{-0.05}^{+0.05}$	2
20	M5X0.8	4.3	10	$\phi 21_{-0.05}^{+0.05}$	3
25	M6X1.0	7.3	12	$\phi 26_{-0.05}^{+0.05}$	3.5

### Front Tapped Hole Mounting

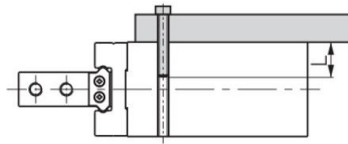

Bore	Bolt Size	Max.Locking Torque (Nm)	Max.Screwed Depth (mm)
10	M3X0.5	0.69	5
16	M4X0.7	2.1	8
20	M5X0.8	4.3	10
25	M6X1.0	7.3	12

### Through Hole Mounting

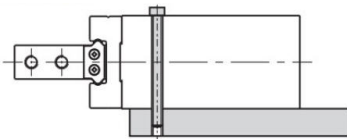

Bore	Bolt Size	Max.Locking Torque (Nm)	Max.Screwed Depth (mm)
10	M2.5X0.45	0.49	5
16	M3X0.5	0.88	8
20	M4X0.7	2.1	10
25	M5X0.8	4.3	12

### Side Tapped Hole Mounting

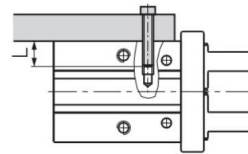

Bore	Bolt Size	Max.Locking Torque (Nm)	Max.Screwed Depth (mm)
10	M3X0.5	0.9	6
16	M4X0.7	1.6	4.5
20	M5X0.8	3.3	8
25	M6X1.0	5.9	10

### 7. Clamping Jaw Installation:

Never clamp the body directly and then lock the screws. The gripping jaw should be held by the spanner and the screw should be locked using a hex wrench.

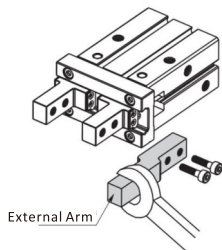

Bore	Bolt Size	Max.Locking Torque (Nm)
10	M2.5X0.45	0.31
16	M3X0.5	0.59
20	M4X0.7	1.4
25	M5X0.8	2.8

### 8. Avoid applying external forces to the gripping jaw.

#### 8.1 The air gripper end of stroke in open status.

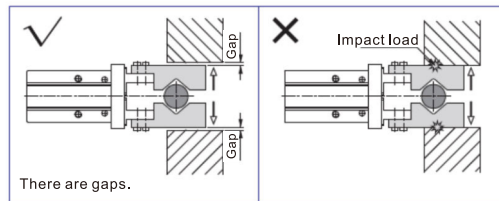

There are gaps.

#### 8.2 The air gripper end of stroke in moving status.

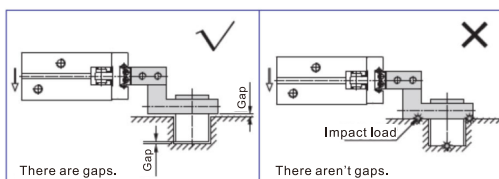

There are gaps.

There aren't gaps.

## Installation and Use

8.3 When reversing your loaded air gripper make sure the object being gripped is centred.

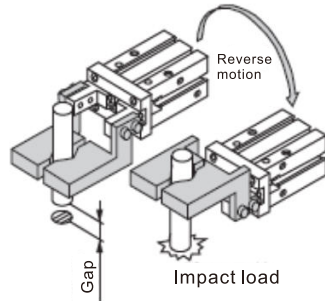

9. When ripping an object the item should always be centred. When testing, you must reduce the pressure for low speed running, to guarantee the safety and no impact.

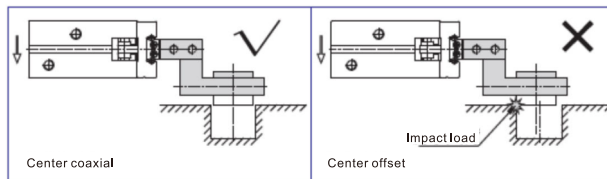

10. Please use the flow control valve to adjust the opening and closing speed of your gripper.

11. Always ensure the gripper path is clear of obstruction.

12. Before removing your air gripper, please make sure all power is disconnected and you've discharged residual compressed air.