

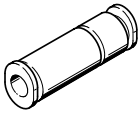

Check valves H/HA/HB

FESTO

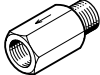
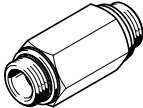
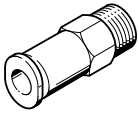

Product range overview

Valve function	Design	Type	Pneumatic connection 1	Pneumatic connection 2	qnN [l/min]	→ Page/ Internet
With non-return function	Push-in connector 	H	QS-4, QS-6, QS-8, QS-10, QS-12	QS-4, QS-6, QS-8, QS-10, QS-12	136 ... 1715	3
	Female thread 	H	M5	M5	115	4
	Male/female thread 		G1/8	G1/8	280	4
	Male thread 		G1/4, G3/8, G1/2, G3/4	G1/4, G3/8, G1/2, G3/4	1000 ... 5900	4
	Male thread/push-in connector 	HA	M5, R1/8, R1/4, R3/8, R1/2	QS-4, QS-6, QS-8, QS-10, QS-12	138 ... 2230	6
HB		QS-4, QS-6, QS-8, QS-10, QS-12	M5, R1/8, R1/4, R3/8, R1/2	142 ... 2206	6	

Data sheet – Push-in connector

Function



- - Flow rate
136 ... 1715 l/min
- - Temperature range
0 ... +60°C
- - Operating pressure
-1 ... +10 bar



General technical data					
Pneumatic connection 1	QS-4	QS-6	QS-8	QS-10	QS-12
Pneumatic connection 2	QS-4	QS-6	QS-8	QS-10	QS-12
Valve function	With non-return function				
Type of mounting	In-line installation				
Mounting position	Any				

Operating and environmental conditions			
Operating pressure	[bar]	-1 ... +10	
Min. differential pressure	Open	[bar]	≥ 0.1
	Close	[bar]	≥ 0.2
Operating medium	Compressed air to ISO 8573-1:2010 [7:-:-]		
Note on the operating/pilot medium	Lubricated operation possible (in which case lubricated operation will always be required)		
Ambient temperature	[°C]	0 ... +60	

Materials					
Pneumatic connection 1	QS-4	QS-6	QS-8	QS-10	QS-12
Housing	Anodised aluminium (colour: black)			Anodised aluminium (colour: silver)	
Note on materials	RoHS-compliant				
	Free of copper and PTFE				

Dimensions

Download CAD data → www.festo.com

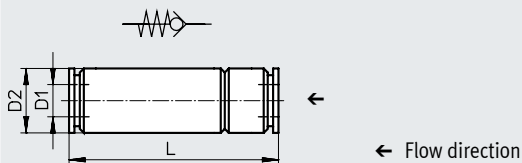

Type	D1	D2	L
H-QS-4	4	9	34.8
H-QS-6	6	12	38.8
H-QS-8	8	15	54.9
H-QS-10	10	25	73.4
H-QS-12	12	25	78.6

Ordering data						
	Pneumatic connection		Standard nominal flow rate q _N [l/min]	Weight [g]	Part no.	Type
	1	2				
	QS-4	QS-4	136	5.3	153462	H-QS-4
	QS-6	QS-6	282	10	153463	H-QS-6
	QS-8	QS-8	681	21	153464	H-QS-8
	QS-10	QS-10	1480	63	153465	H-QS-10
	QS-12	QS-12	1715	69	153466	H-QS-12

Data sheet – Threaded connection

Function



- - Flow rate
115 ... 5900 l/min
- - Temperature range
-10 ... +60°C
- - Operating pressure
0.4 ... 12 bar



H-M5

H-1/8-A/I

H-...-B

General technical data

Pneumatic connection 1	M5	G1/8	G1/4	G3/8	G1/2	G3/4
Pneumatic connection 2	M5	G1/8	G1/4	G3/8	G1/2	G3/4
Valve function	With non-return function					
Type of mounting	In-line installation		Screw-in			
Mounting position	Any					
Nominal tightening torque [Nm]	-	-	11 ±10%	12.5 ±20%	14 ±20%	35 ±10%

† Note: This product conforms to ISO 1179-1 and ISO 228-1.

Operating and environmental conditions

Pneumatic connection 1	M5	G1/8	G1/4	G3/8	G1/2	G3/4
Operating pressure for entire temperature range [bar]	0.4 ... 8		0.4 ... 12			
Operating medium	Compressed air to ISO 8573-1:2010 [7:-:-]		Compressed air to ISO 8573-1:2010 [7:4:4]			
Note on the operating/pilot medium	Lubricated operation possible (in which case lubricated operation will always be required)					
Ambient temperature [°C]	-10 ... +60					
Temperature of medium [°C]	-10 ... +60					
Storage temperature [°C]	-		-10 ... +60			
Corrosion resistance class CRC ¹⁾	-		2			

1) Corrosion resistance class CRC 2 to Festo standard FN 940070

Moderate corrosion stress. Indoor applications in which condensation can occur. External visible parts with primarily decorative surface requirements which are in direct contact with a normal industrial environment.

Materials

Pneumatic connection 1	M5	G1/8	G1/4	G3/8	G1/2	G3/4
Housing	Brass		Anodised wrought aluminium alloy			
Seals	NBR					
Note on materials	RoHS-compliant	-	RoHS-compliant			
	-	-	Free of copper and PTFE			

Data sheet – Threaded connection

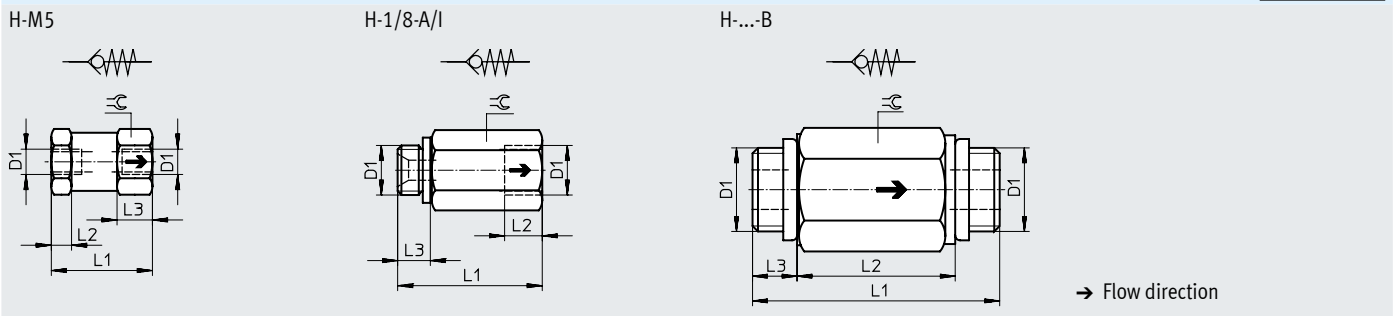

Dimensions

Download CAD data → www.festo.com

Type	D1	L1	L2	L3	☉
H-M5	M5	20	4	7	11
H-1/8-A/I	G1/8	28.5	7.5	6.5	13
H-1/4-B	G1/4	48	32	8	19
H-3/8-B	G3/8	50	32	9	22
H-1/2-B	G1/2	65	44	10.5	27
H-3/4-B	G3/4	74	50	12	32

† Note: This product conforms to ISO 1179-1 and ISO 228-1.

Ordering data

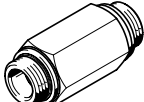

	Pneumatic connection		Standard nominal flow rate q _n [l/min]	Weight [g]	Part no.	Type
	1	2				
	M5	M5	115	15	3671	H-M5
	G1/8	G1/8	280	21	3324	H-1/8-A/I ¹⁾
	G1/4	G1/4	1000	25.4	11689	H-1/4-B ¹⁾
	G3/8	G3/8	2000	34	11690	H-3/8-B ¹⁾
	G1/2	G1/2	5500	58.3	11691	H-1/2-B ¹⁾
	G3/4	G3/4	5900	101	11692	H-3/4-B ¹⁾

1) Sealing rings for male thread are included in the scope of delivery.

Data sheet

Function



-  - Flow rate
138 ... 2230 l/min
-  - Temperature range
0 ... +60°C
-  - Operating pressure
-1 ... +10 bar

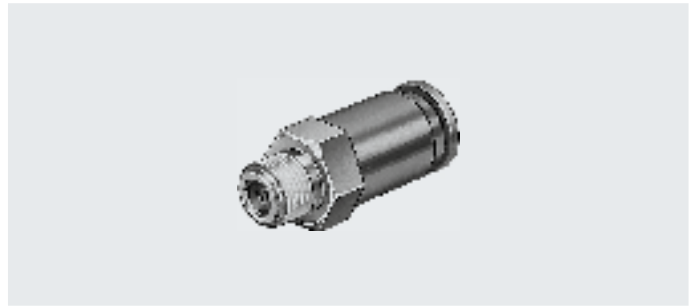

General technical data										
Type	HA					HB				
Pneumatic connection 1	M5	R1/8	R1/4	R3/8	R1/2	QS-4	QS-6	QS-8	QS-10	QS-12
Pneumatic connection 2	QS-4	QS-4, QS-6, QS-8	QS-6, QS-8	QS-10, QS-12	QS-12	M5, R1/8	R1/8, R1/4	R1/8, R1/4	R3/8	R3/8, R1/2
Valve function	With non-return function									
Type of mounting	Screw-in									
Mounting position	Any									

Operating and environmental conditions			
Operating pressure	[bar]	-1 ... +10	
Min. differential pressure	Open	[bar]	≥ 0.1
	Close	[bar]	≥ 0.2
Operating medium	Compressed air to ISO 8573-1:2010 [7:-:-]		
Note on the operating/pilot medium	Lubricated operation possible (in which case lubricated operation will always be required)		
Ambient temperature	[°C]	0 ... +60	

Materials										
Type	HA					HB				
Pneumatic connection 1	M5	R1/8	R1/4	R3/8	R1/2	QS-4	QS-6	QS-8	QS-10	QS-12
Housing	Nickel-plated brass			Anodised aluminium (colour: silver)		Nickel-plated brass			Anodised aluminium (colour: silver)	
Note on materials	RoHS-compliant									

Data sheet

Dimensions

Download CAD data → www.festo.com

HA/HB-M5-QS

HA/HB-...-QS

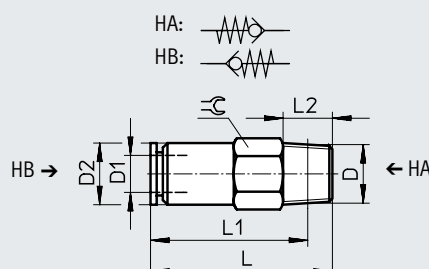
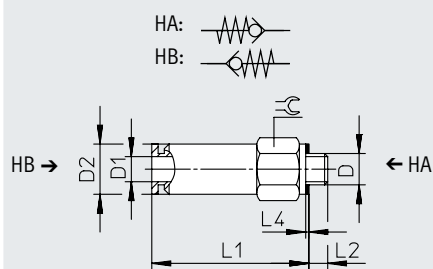

← Flow direction

Type	D	D1 ø	D2 ø	L	L1	L2	L4	≈
HA/HB-M5-QS-4	M5	4	8	-	25.4	3	0.5	8
HA/HB-1/8-QS-4	R1/8	4	9	24.5	20.5	8	-	10
HA/HB-1/8-QS-6	R1/8	6	10	29.3	25.3	8	-	10
HA/HB-1/8-QS-8	R1/8	8	13.5	35.5	31.5	8	-	14
HA/HB-1/4-QS-6	R1/4	6	12	29.3	23.3	11	-	14
HA/HB-1/4-QS-8	R1/4	8	13.5	39.2	33.2	11	-	14
HA/HB-3/8-QS-10	R3/8	10	25	61.7	55.4	12	-	24
HA/HB-3/8-QS-12	R3/8	12	25	64.3	58	12	-	24
HA/HB-1/2-QS-12	R1/2	12	28	70.8	62.6	15	-	27

Ordering data

	Pneumatic connection		Standard nominal flow rate q _n N [l/min]	Weight [g]	Part no.	Type
	1	2				

Flow direction: male thread → push-in connector QS

	M5	QS-4	148	7.2	153444	HA-M5-QS-4	
		R1/8	QS-4	138	11	153446	HA-1/8-QS-4
			QS-6	311	11	153448	HA-1/8-QS-6
			QS-8	331	22	153452	HA-1/8-QS-8
	R1/4	QS-6	302	23	153450	HA-1/4-QS-6	
		QS-8	670	24	153454	HA-1/4-QS-8	
	R3/8	QS-10	1740	47	153456	HA-3/8-QS-10	
		QS-12	1876	50	153458	HA-3/8-QS-12	
	R1/2	QS-12	2230	69	153460	HA-1/2-QS-12	

Flow direction: push-in connector QS → male thread

	QS-4	M5	144	7.2	153445	HB-M5-QS-4
		R1/8	142	11	153447	HB-1/8-QS-4
	QS-6	R1/8	335	11	153449	HB-1/8-QS-6
		R1/4	294	23	153451	HB-1/4-QS-6
	QS-8	R1/8	314	22	153453	HB-1/8-QS-8
		R1/4	696	24	153455	HB-1/4-QS-8
	QS-10	R3/8	1700	47	153457	HB-3/8-QS-10
	QS-12	R3/8	1886	50	153459	HB-3/8-QS-12
		R1/2	2206	69	153461	HB-1/2-QS-12