

Modulverbinder MS6-9-ARMV/MS9-12-ARMV

FESTO

Festo AG & Co. KG

Postfach
D-73726 Esslingen
++49/(0)711/347-0
www.festo.com

Bestimmungsgemäß dient der Modulverbinder MS6-9-ARMV / MS9-12-ARMV als Adapter bzw. 90°-Adapter zwischen den Wartungsgeräten **10** und **11**.

1. Teileliste

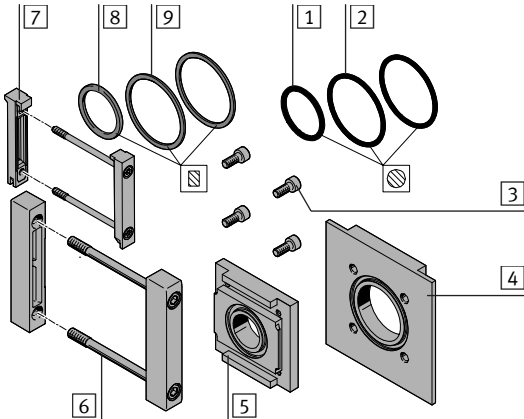

Pos.	Bezeichnung	Bei MS6-9-ARMV	Bei MS9-12-ARMV
1	O-Ring	29x3	42x2,5 (2x) ¹⁾
2	O-Ring	42x2,5 (2x) ¹⁾	63x3
3	Schraube	M5x12 (4x)	M5x12 (4x)
4	Modulverbinder	MS9-AMV/RMV-9	MS9-AMV/RMV-12
5	Modulverbinder	MS9-AMV/RMV-6	MS9-AMV/RMV-9
6	Modulverbinder	MS9-MV ²⁾	MS12-MV ²⁾
7	Modulverbinder	MS6-MV	MS9-MV
8	Flachdichtung	MS6-NNR	MS9-NNR (2x) ¹⁾
9	Flachdichtung	MS9-NNR (2x) ¹⁾	MS12-NNR
Nicht im Lieferumfang:			
10	Wartungsgerät	MS6-...	MS9-...
11	Wartungsgerät	MS9-...	MS12-...

2. Anziehdrehmomente

Pos.	Bezeichnung	Bei MS6-9-ARMV	Bei MS9-12-ARMV
3	Schraube	4,5 Nm ± 10%	4,5 Nm ± 10%
6	Modulverbinder	8,0 Nm ± 10%	17,5 Nm ± 14%
7	Modulverbinder	1,2 Nm ± 10%	8,0 Nm ± 10%

→ Hinweis

- Bei Größenadaptation in Verbindung mit Wandbefestigungen:
- Verwenden Sie nach dem Größensprung mindestens einen Befestigungswinkel MS...-W... der größeren Baureihe.
 - Beachten Sie dazu auch die vorgeschriebenen Montageabstände der Befestigungswinkel in der zugehörigen Bedienungsanleitung.

Je nach Montagevariante bleibt eine Flachdichtung **8** oder **9** übrig.

¹⁾ Montieren Sie den O-Ring 42x2,5 **1** / **2** und die Flachdichtung MS9-NNR **8** / **9** zwischen Modulverbinder **4** und **5**.

²⁾ Alternativ kann für Modulverbinder **6** auch ein Befestigungswinkel MS9-W... bzw. MS12-W... für die Wandmontage eingesetzt werden, der sich jedoch nicht im Lieferumfang befindet.

3. Montage Variante 1 Wartungsgerät **11** rechts Wartungsgerät **10** links

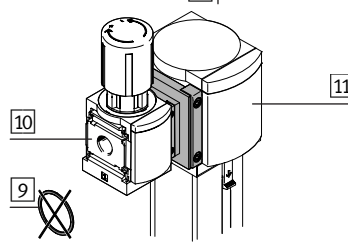
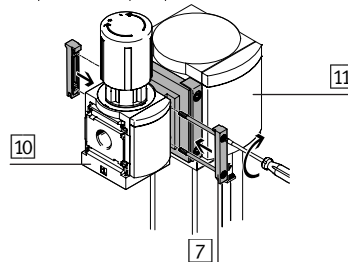
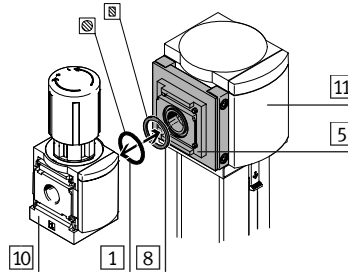
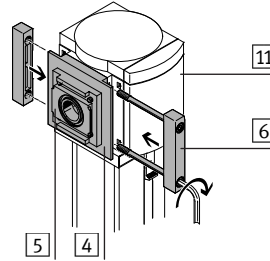
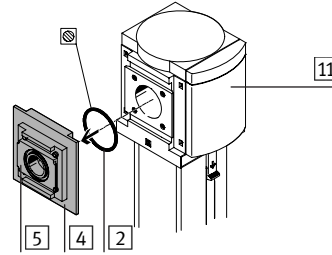
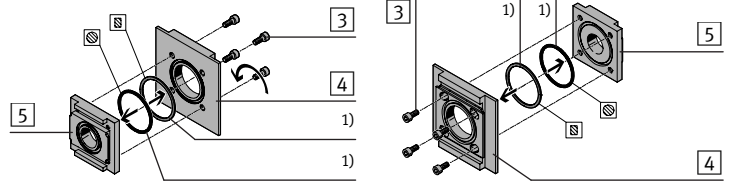

3a. Variante 1 als 90°-Adapter

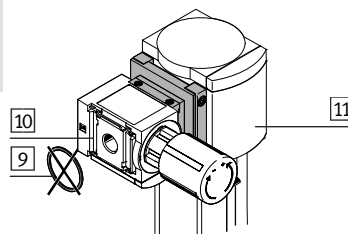
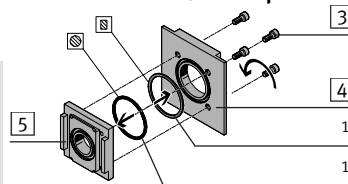

4. Montage Variante 2 Wartungsgerät **10** rechts Wartungsgerät **11** links

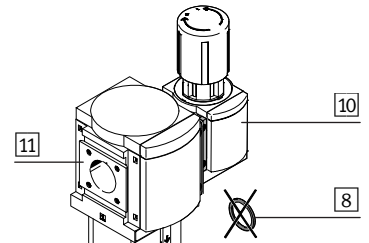
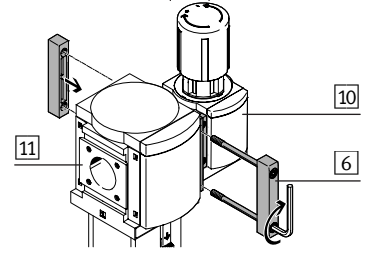
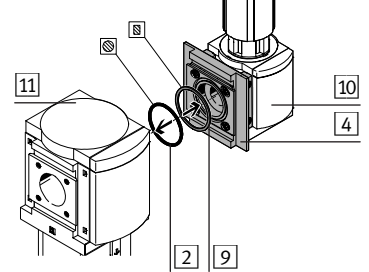
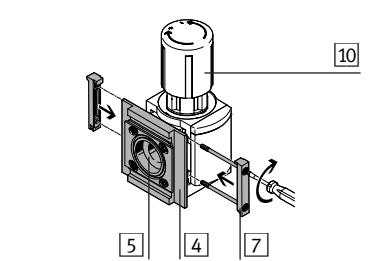
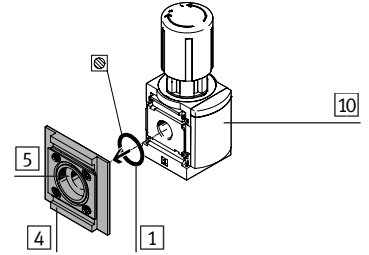
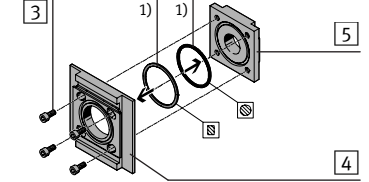

4a. Variante 2 als 90°-Adapter

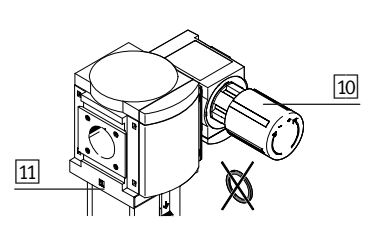
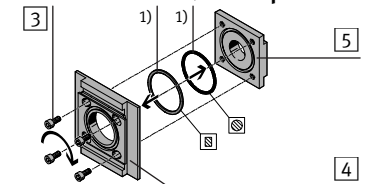

FESTO

Festo AG & Co. KG

Postfach
D-73726 Esslingen
++49/(0)711/347-0
www.festo.com

Module connector MS6-9-ARMV/MS9-12-ARMV

The module connector MS6-9-ARMV / MS9-12-ARMV is intended as an adapter or 90°-adapter between service units **10** and **11**.

1. Parts list

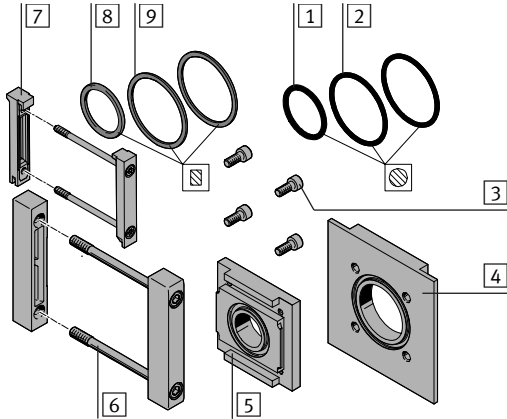

Pos.	Designation	with MS6-9-ARMV	with MS9-12-ARMV
1	O-ring	29x3	42x2,5 (2x) ¹⁾
2	O-ring	42x2,5 (2x) ¹⁾	63x3
3	Screw	M5x12 (4x)	M5x12 (4x)
4	Module connector	MS9-AMV/RMV-9	MS9-AMV/RMV-12
5	Module connector	MS9-AMV/RMV-6	MS9-AMV/RMV-9
6	Module connector	MS9-MV ²⁾	MS12-MV ²⁾
7	Module connector	MS6-MV	MS9-MV
8	Flat seal	MS6-NNR	MS9-NNR (2x) ¹⁾
9	Flat seal	MS9-NNR (2x) ¹⁾	MS12-NNR
Not included in scope of delivery:			
10	Service unit	MS6-...	MS9-...
11	Service unit	MS9-...	MS12-...

2. Tightening torque

Pos.	Designation	with MS6-9-ARMV	with MS9-12-ARMV
3	Screw	4,5 Nm ± 10%	4,5 Nm ± 10%
6	Module connector	8,0 Nm ± 10%	17,5 Nm ± 14%
7	Module connector	1,2 Nm ± 10%	8,0 Nm ± 10%

→ Note

Adapting the size in conjunction with wall fastenings:

- After the change in size use at least one fastening bracket MS...-W... of the larger series.
- Note also the specified mounting gaps for the fastening brackets in the relative operating instructions.

Depending on the mounting variant a flat seal 8 or 9 will remain unused.

¹⁾ Fit the O-ring 42x2,5 **1** / **2** and the flat seal MS9-NNR **8** / **9** between module connector **4** and **5**.

²⁾ Alternatively a fastening bracket MS9-WP or MS12-WP can also be used for module connector **6** for fitting onto a wall. However this is not included in scope of delivery.

3. Fitting variant 1

Service unit **11** right
Service unit **10** left

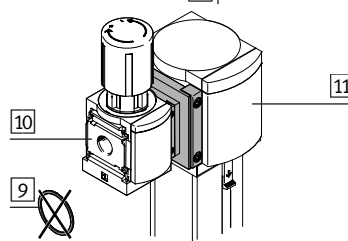
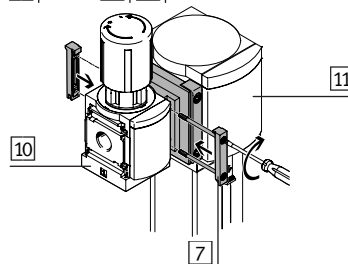
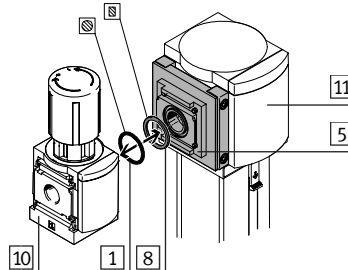
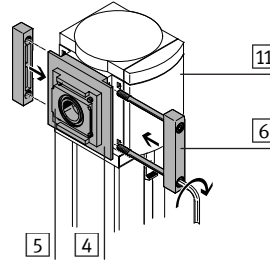
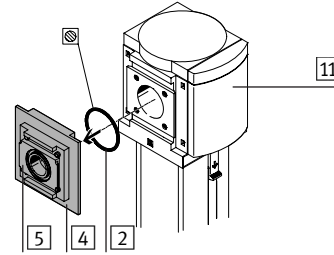
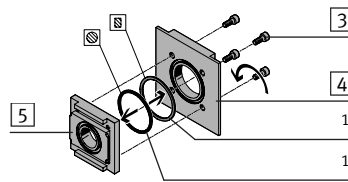

3a. Variant 1 as 90°-Adapter

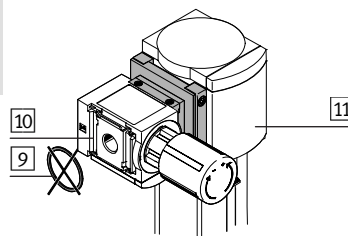
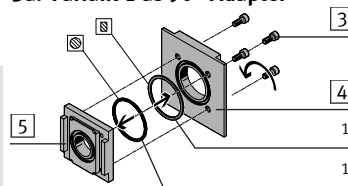

4. Fitting variant 2

Service unit **10** right
Service unit **11** left

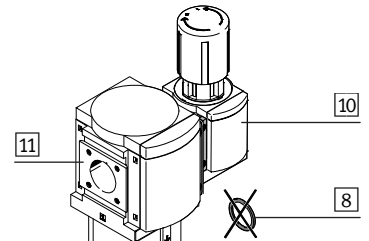
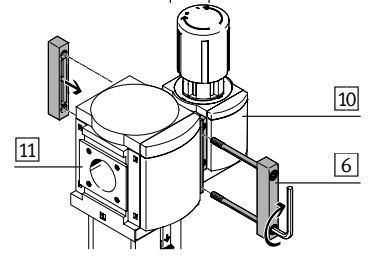
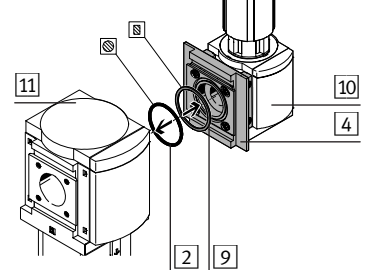
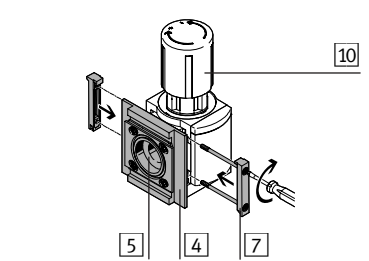
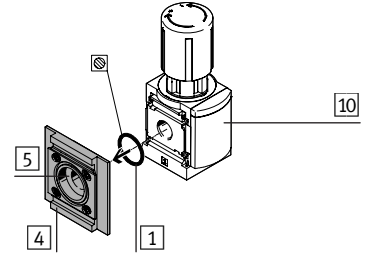
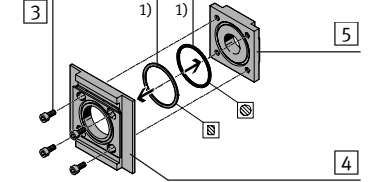

4a. Variant 2 as 90°-Adapter

