

## Vacuum generators OVM

**FESTO**



## Key features

### At a glance

Rapid purging of vacuum for safe placement of the workpiece using an integrated solenoid valve to control the ejector pulse

Central electrical connection via an M12 plug

#### OVEM-...-1PD/2P/2N/PU/PI/LK

Monitoring and visualisation of the vacuum pressure using a vacuum sensor with LCD display (bar)

#### OVEM-...-LK

Vacuum sensor with IO-Link

Adjustment of the ejector pulse via a flow control screw

Contamination of the vacuum generator is prevented by an integrated filter

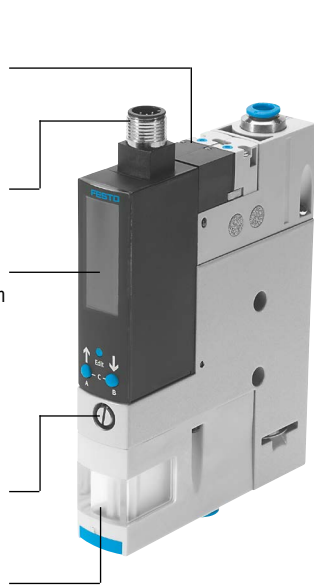

Quick and secure installation thanks to QS fitting

Fast vacuum build-up using an integrated solenoid valve to control the compressed air supply

#### OVEM-...-1P/1N

Monitoring of the vacuum pressure and status displays for switching output and solenoid valves using a vacuum sensor with LED display

Prevention of pressure drop using an integrated check valve

Maintenance-free operation and reduced noise level through an integrated, open silencer



### The modular vacuum generator series

The modular series of vacuum generators OVEM offers a wide range of individually selectable functions, providing numerous solutions for a wide variety of applications.

Functions	Values
Laval nozzle	0.45 mm
	0.7 mm
	0.95 mm
	1.4 mm
	2.0 mm
	3.0 mm
Vacuum generator characteristics	High vacuum
	High suction rate
Housing size	20 mm, metric version, display in bar
	20 mm, NPT version, display in inchHg <sup>1)</sup>
	36 mm, metric version, display in bar
Pneumatic connections	QS fittings, with or without open silencer
	QS fittings (inch), with or without open silencer <sup>1)</sup>
	G female thread, with or without open silencer
	NPT female thread, with or without open silencer <sup>1)</sup>
	Prepared for supply manifold
Normal position of the vacuum generator	Normally open, with or without ejector pulse
	Normally closed, with or without ejector pulse
Electrical connection	M12 plug (5-pin)
Vacuum sensor	Without vacuum sensor
	1 switching output PNP or NPN, LED display
	1 switching output PNP, LCD display
	2 switching outputs PNP or NPN, LCD display
	1 switching output PNP and 1 analogue output, LCD display
Alternative vacuum display	IO-Link, LCD display
	inchHg <sup>2)</sup>
	inchH <sub>2</sub> O <sup>1) 2)</sup>
	bar <sup>2)</sup>

1) Product documentation → Internet: ovem-npt

2) Vacuum sensor with LCD display

## Key features

### The innovative vacuum generator

#### Economical

- Short switching times thanks to integrated solenoid valves
  - Vacuum on/off
  - Ejector pulse
- Quick, precise and safe placement of the workpiece via the ejector pulse
- Cost saving through preventive maintenance/service thanks to maintenance display

#### Reliable

- Permanent monitoring of the entire vacuum system via a vacuum sensor to reduce downtimes (condition monitoring)
- Prevention of pressure drop using an integrated air-saving function in conjunction with an integrated check valve

#### Space-saving

- All functions are compactly integrated in one unit.
- No protruding elements such as valves or vacuum sensors
- Space-optimised installation is possible as all the control elements can be accessed from one side

#### Easy to use

- Simple installation using M12 plugs and QS fittings
- Straightforward mounting with retaining screws
- All control elements on one side
- Low-noise operation due to integrated silencer

- Vacuum sensor with LCD display (OVEM-...-1PD/2P/2N/PU/PI/LK)
  - Vacuum is displayed numerically and as a bar chart
  - Important parameters and diagnostic information are displayed

#### Easy to maintain

- Integrated filter with inspection window for maintenance display
- Reduced contamination of the vacuum generator thanks to an open silencer

#### Choice of mounting types

- Direct mounting or via mounting bracket
- Straightforward mounting on H-rail via accessories
- Linking of multiple vacuum generators on a common supply manifold (→ page 23)

## Key features

### Functional principle of OVEM

#### Vacuum ON/OFF

The compressed air supply is controlled by an integrated solenoid valve. The solenoid valve is available in two different switching functions, NC/NO.

- NC - normally closed:  
The vacuum is generated when the vacuum generator is pressurised with compressed air and the solenoid valve has been switched.
- NO - normally open:  
The vacuum is generated when the vacuum generator is pressurised with compressed air and the solenoid valve is in the normal position.

#### Ejector pulse

After the vacuum is switched off, an ejector pulse is activated and generated by a second integrated solenoid valve to release the workpiece safely from the suction cup and to purge the vacuum quickly.

#### Power ejector pulse

A power ejector pulse is generated by means of an additional shut-off piston, thus preventing the ejector pulse from escaping via the silencer.

#### Note

Use the power ejector pulse only in open vacuum systems as the exhaust duct is sealed tightly during the ejector pulse. This can cause overpressure at the vacuum port and destroy the vacuum sensor.

#### Vacuum sensor

The set or taught-in setpoint value for the generated vacuum is monitored via an integrated vacuum sensor. If the setpoint value is reached or if it is not reached due to malfunctions (e.g. leakages, dropped workpiece), the vacuum sensor emits an electrical signal.

### Connection to higher-level systems and configuration of the switching outputs

#### OVEM-...-1P/1PD/1N

- Switching inputs for actuating the solenoid valves for vacuum generation and ejector pulse
- OVEM-...-1P/1N only:  
One switching output for supplying a control signal
  - Configured as an N/O contact
  - Switching function configured as a threshold value comparator
- OVEM-...-1PD only:  
One digital switching output for supplying a control signal
  - Switching output can be configured as N/C or N/O contact
  - Switching function of the output can be configured as a threshold value or window comparator

#### OVEM-...-2P/2N/PU/PI

- One digital switching input for actuating the solenoid valves
- Two digital switching outputs or one digital switching output and one analogue output for supplying control signals
  - Switching outputs can be configured as N/C or N/O contacts
  - Switching function of the outputs can be configured as a threshold value or window comparator

- If there are two switching outputs, these can be configured independently of each other. This enables tasks to be performed in parallel with one vacuum generator, reducing the time needed for sorting good and reject parts, for example.

#### OVEM-...-LK

- Digital setpoint and actual value transfer for simple parameterisation and diagnostic feedback. Communication takes place in IO-Link mode with an IO-Link master.
- SIO mode is supported. In the case of this local configuration using the operating buttons on the vacuum sensor, the OVEM takes on the function of an OVEM-...-2P.

## Key features

### Air saving function (with OVEM-...-OE/OPE/CE/CPE-...-1PD/2P/2N/PU/PI/LK)

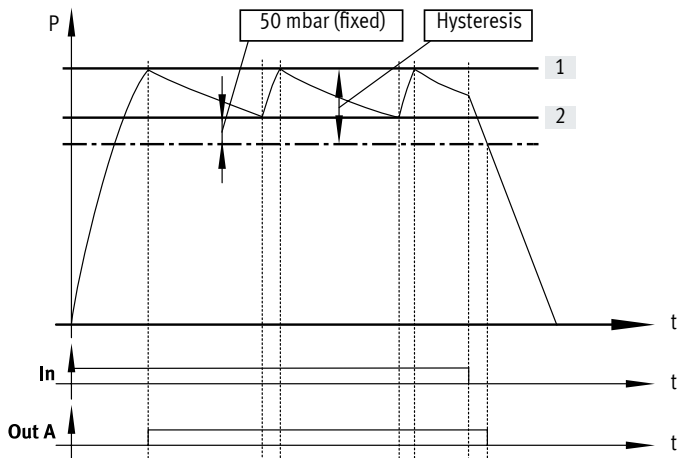

If the desired threshold value [1] for the vacuum is reached, vacuum generation is automatically switched off. A check valve prevents a decrease of the vacuum. Nonetheless, leakage (e.g. due to rough workpiece surfaces) will slowly reduce the vacuum. If the vacuum drops below the threshold value [2], vacuum generation is automatically switched on. Vacuum is generated until the set threshold value [1] is reached again.

### Condition monitoring and diagnostics (with OVEM-...-1PD/2P/2N/PU/PI/LK)

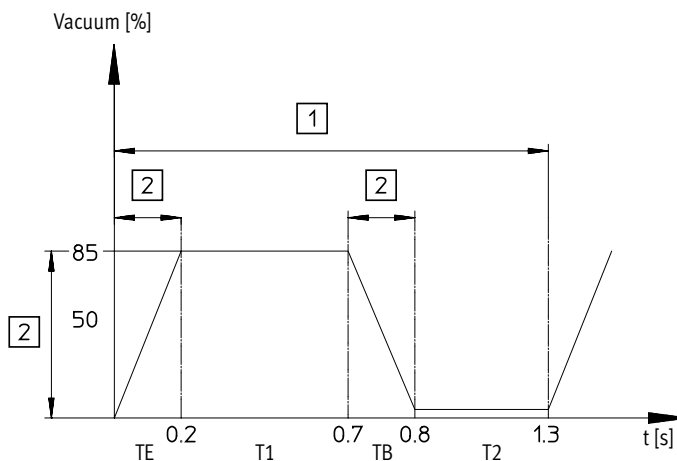

- |                    |                    |
|--------------------|--------------------|
| [1] Cycle time     | T1 Transport time  |
| [2] Monitoring     | TB Air supply time |
| TE Evacuation time | T2 Return time     |

The most important operating parameters:

- Vacuum
- Evacuation time
- Air supply time

are continuously measured in the vacuum generator and compared with the individually set setpoint values (condition monitoring). If deviations in the setpoint values occur, these will be determined by the vacuum generator and shown on the display (diagnostics).

In addition, in the case of an OVEM with two switching outputs (OVEM-...-2P/2N, OVEM-...-LK in SIO mode), diagnostic messages can also be transmitted by the switching output Out B.

This enables preventive action to be taken:

- in order to prevent machine failure or downtime, for example, through timely maintenance
- and to ensure process reliability (adherence to the cycle time).

### From the teach-in point to the switching point (with OVEM-...-1P/1N)

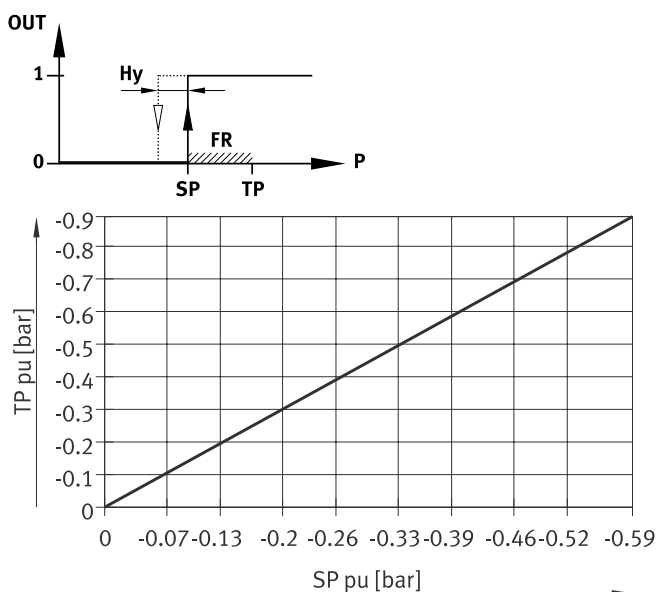

- |                    |                     |
|--------------------|---------------------|
| TP Teach-in point  | Hy Hysteresis       |
| SP Switching point | FR Function reserve |

The switching point is determined from the teach pressure and the function reserve.

A function reserve (35% of the teach pressure) is deducted from the teach pressure ( $SP = TP - 0.35 \cdot TP$ ).

For example, with a teach pressure of  $-0.5$  bar, a switching point of  $-0.33$  bar is set.

The hysteresis has a fixed value.

Peripherals overview

OVEM-...-QS/QO/GN/GO

OVEM-...-PL/PO<sup>1)</sup>

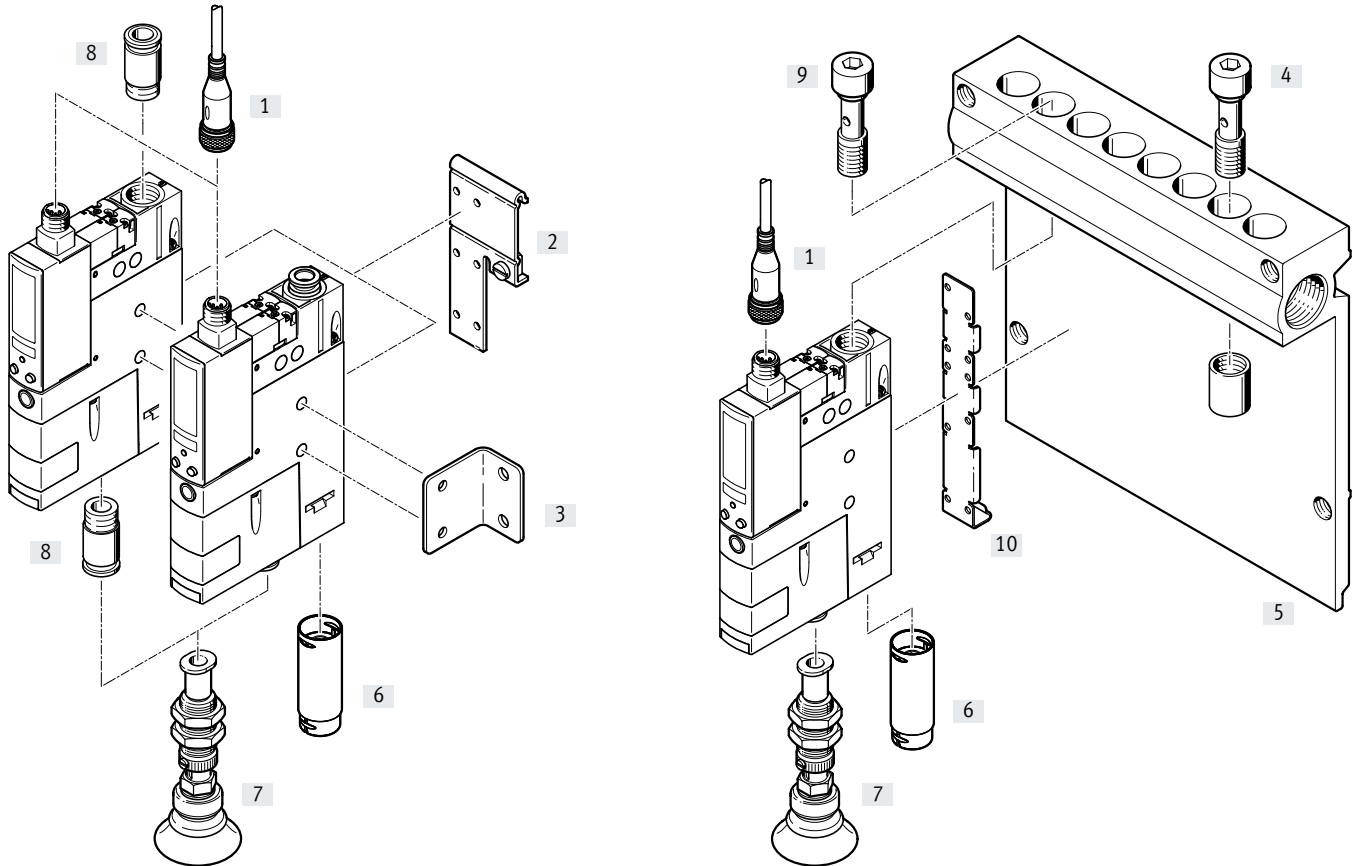

1) Hollow bolt [9] and mounting bracket [10] are included in the scope of delivery for the OVEM-...-PL/PO.

**Mounting attachments and accessories**

Type	OVEM-...-B						OVEM-...-C						→ Page/Internet
Pneumatic connections	[QS]	[QO]	[GN]	[GO]	[PL]	[PO]	[QS]	[QO]	[GN]	[GO]	[PL]	[PO]	
[1] Connecting cable NEBU-M12		■				■					■		26
[2] H-rail mounting OABM-H		■			-						-		25
[3] Mounting bracket HRM-1		■			-						-		26
[4] Blanking plug OASC-G1-P		-			■						■		25
[5] P manifold rail OABM-P		-			■						■		23
[6] Silencer extension UOMS-1/4	-	■ <sup>2)</sup>	-	■ <sup>2)</sup>	-	■ <sup>2)</sup>							26
Silencer extension UOMS-3/8		-					-	■	-	■	-	■	26
[7] Suction gripper ESG		■			■					■			esg
[8] Push-in fitting QS	-		■		-		-			■			qs
- Suction cup holder ESH		■			■					■			esh
- Suction cup with connection ESS		■			■					■			ess

2) Silencer extension UOMS-1/4 [6] is included in the scope of delivery of the OVEM-20.

## Type codes

<b>001</b>	<b>Series</b>	
<b>OVEM</b>	Vacuum generator	
<b>002</b>	<b>Nominal width of Laval nozzle</b>	
<b>05</b>	0.45 mm	
<b>07</b>	0.70 mm	
<b>10</b>	0.95 mm	
<b>14</b>	1.4 mm	
<b>20</b>	2.0 mm	
<b>30</b>	3.0 mm	
<b>003</b>	<b>Vacuum type</b>	
<b>H</b>	High vacuum	
<b>L</b>	High suction rate	
<b>004</b>	<b>Housing width</b>	
<b>B</b>	20 mm	
<b>C</b>	36 mm	
<b>005</b>	<b>Pneumatic connections</b>	
<b>QS</b>	All connections with QS fittings	
<b>QO</b>	Supply/vacuum port with QS fittings, exhaust port with open silencer	
<b>GN</b>	All connections with G female thread	
<b>GO</b>	Supply/vacuum port with G female thread, exhaust port with open silencer	
<b>PL</b>	Prepared for supply manifold, vacuum port and exhaust port with QS fittings	
<b>PO</b>	Prepared for supply manifold, vacuum port with QS fittings, exhaust port with open silencer	

<b>006</b>	<b>Normal position of the vacuum generator</b>	
<b>ON</b>	NO, normally open (vacuum generation)	
<b>OE</b>	NO, normally open (vacuum generation) with ejector pulse	
<b>OPE</b>	NO, normally open (vacuum generation) with powerful ejector pulse	
<b>CN</b>	NC, normally closed (no vacuum generation)	
<b>CE</b>	NC, normally closed (no vacuum generation) with ejector pulse	
<b>CPE</b>	NC, normally closed (no vacuum generation) with powerful ejector pulse	

<b>007</b>	<b>Electrical connection</b>	
<b>N</b>	Plug M12 (5-pin)	

<b>008</b>	<b>Vacuum sensor</b>	
	Without vacuum sensor (switching input PNP)	
<b>1P</b>	Switching output 1x PNP	
<b>1PD</b>	Switching output 1 x PNP and display	
<b>1N</b>	Switching output 1 x NPN	
<b>2P</b>	Switching output 2x PNP	
<b>PU</b>	Switching output 1 x PNP + U	
<b>PI</b>	Switching output 1 x PNP + I	
<b>2N</b>	Switching output 2 x NPN	
<b>LK</b>	IO-Link®	



<b>009</b>	<b>Alternative vacuum display</b>	
	Without	
<b>H</b>	Inch Hg	

## Data sheet

### Function

NC, normally closed:

- Ejector pulse
- QS fitting or G female thread
- With open silencer
- Prepared for common supply manifold

-  Temperature range  
0 ... +50°C
-  Operating pressure  
2 ... 8 bar
-  Spare parts service

NO, normally open:

- Ejector pulse
- QS fitting or G female thread
- With open silencer
- Prepared for common supply manifold

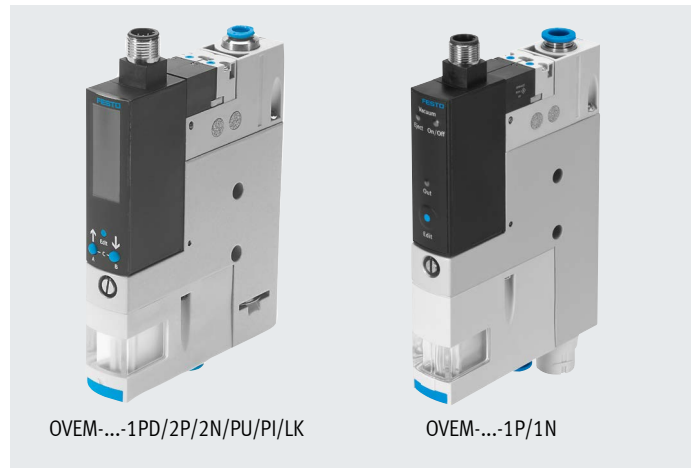

### General technical data

Type	OVEM-...-B						OVEM-...-C	
Nominal width of Laval nozzle [mm]	0.45	0.7	0.95	1.4	2.0	2.0	3.0	
Grid dimension [mm]	20						36	
Grade of filtration [µm]	40						-	
Mounting position	Any							
Type of mounting	With through-hole Via female thread With accessories							
Pneumatic port 1 (P)	→ Dimensions on page 16							
Vacuum port (V)	→ Dimensions on page 16							
Pneumatic port 3 (R)	→ Dimensions on page 16							

### Technical data – Design

Type	OVEM-...-QO/GO/PO		OVEM-...-QS/GN/PL
Design	Modular		
Ejector characteristic	High vacuum High suction rate		
Silencer design	Open		-
Integrated function [ON]/[CN]  [OE]/[OPE]/[CE]/[CPE]	Electric on/off valve		Electric on/off valve
	Vacuum sensor <sup>1)</sup>		Vacuum sensor <sup>1)</sup>
	Filter		Filter
	Open silencer		-
	Electric on/off valve		Electric on/off valve
	Ejector pulse / power ejector pulse, electrical		Ejector pulse / power ejector pulse, electrical
	Flow control valve		Flow control valve
	Vacuum sensor <sup>1)</sup>		Vacuum sensor <sup>1)</sup>
	Air saving function, electrical <sup>2)</sup>		Air saving function, electrical <sup>2)</sup>
	Check valve		Check valve
	Filter		Filter
	Open silencer		-
Valve function [ON]/[OE]/[OPE] [CN]/[CE]/[CPE]	Open		
	Closed		
Manual override	Non-detenting		
	Additionally via operating buttons <sup>2)</sup>		

1) Only with OVEM-...-1P/1PD/1N/2P/2N/PU/PI/LK

2) Only possible with OVEM-...-1PD/2P/2N/PU/PI/LK



## Data sheet

Operating and environmental conditions		OVEM-...-QO/GO/PO		OVEM-...-QS/GN/PL	
				Without vacuum sensor	With vacuum sensor
Type					
Operating pressure	[bar]	2 ... 8		2 ... 8	2 ... 6
Nominal operating pressure	[bar]	6			
Operating medium		Compressed air to ISO 8573-1:2010 [7:4:4]			
Note on the operating/pilot medium		Operation with lubricated medium not possible			
Ambient temperature	[°C]	0 ... +50			
Temperature of medium	[°C]	0 ... +50			
Relative humidity	[%]	5 ... 85			
Protection class		III			
Degree of protection		IP65			
Corrosion resistance class CRC <sup>1)</sup>		2			
CE marking (see declaration of conformity) <sup>2)</sup>		To EU EMC Directive			
Certification		c UL us - Listed (OL) (OVEM-...-B only)			
		RCM compliance mark			
KC mark		KC EMC			

1) Corrosion resistance class CRC 2 to Festo standard FN 940070

Moderate corrosion stress. Indoor applications in which condensation can occur. External visible parts with primarily decorative surface requirements which are in direct contact with a normal industrial environment.

2) For information about the area of use, see the EC declaration of conformity at: [www.festo.com/sp](http://www.festo.com/sp) → Certificates.

If the devices are subject to usage restrictions in residential, commercial or light-industrial environments, further measures for the reduction of the emitted interference may be necessary.

Performance data – High vacuum		OVEM-...-B					OVEM-...-C	
Type								
Nominal width of Laval nozzle	[mm]	0.45	0.7	0.95	1.4	2.0	2.0	3.0
Max. vacuum	[%]	93						
Operating pressure for max. vacuum	[bar]	5.1	4.1	3.5	3.6	5.3	4	4
Max. suction rate with respect to atmosphere	[l/min]	6	16	19.5	50.5	86.5	98	181
Suction rate at p <sub>1</sub> = 6 bar	[l/min]	5.9	15.1	18.6	46	80.5	93.4	173.8
Air supply time <sup>1)</sup> for 1 l volume, at p <sub>1</sub> = 6 bar	[ON]/[CN] [s]	4.8	1.9	1.2	0.6	0.4	0.4	0.3
	[OE]/[CE] [s]	2	0.4	0.2	0.2	0.2	0.2	0.2
	[OPE]/[CPE] [s]	–	–	–	–	–	0.15	0.15
Noise level at p <sub>1</sub> = 6 bar	[db(A)]	51	58	73	77	74	62	75

1) Time required to reduce the vacuum to a residual vacuum of –0.05 bar

Performance data – High suction rate		OVEM-...-B					OVEM-...-C	
Type								
Nominal width of Laval nozzle	[mm]	0.45	0.7	0.95	1.4	2.0	2.0	3.0
Max. suction rate with respect to atmosphere	[l/min]	13	31.5	45	92	190	190	348
Suction rate at p <sub>1</sub> = 6 bar	[l/min]	12.8	31.5	45.1	88.7	182.5	182.5	320
Air supply time <sup>1)</sup> for 1 l volume, at p <sub>1</sub> = 6 bar	[ON]/[CN] [s]	2	1	0.8	0.4	0.3	0.3	0.3
	[OE]/[CE] [s]	1.3	0.2	0.2	0.2	0.2	0.2	0.2
	[OPE]/[CPE] [s]	–	–	–	–	–	0.15	0.15
Noise level at p <sub>1</sub> = 6 bar	[db(A)]	45	53	64	70	57	57	69

1) Time required to reduce the vacuum to a residual vacuum of –0.05 bar

Data sheet

Technical data – Electrical data, general							
Type		Without vacuum sensor	With vacuum sensor				
			OVEM-...-1P/1N	OVEM-...-1PD	OVEM-...-2P/2N	OVEM-...-PU/PI	OVEM-...-LK
Electrical connection		Plug M12x1, 5-pin					
Switching input to standard		IEC 61131-2					
Operating voltage range	[V DC]	20.4 ... 27.6					
Duty cycle	[%]	100					
Coil characteristics 24 V DC	[W]	Low-current phase: 0.3					
		High-current phase: 2.55					
Max. current consumption	[mA]	30	180	170	270	180	150 (270 in SIO mode)
Insulation voltage	[V]	50					
Surge resistance	[kV]	0.8					
Contamination level		3					
Reverse polarity protection		For all electrical connections					
Switching position indication		LED		LCD			

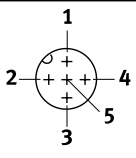
Pin allocation		
Plug M12x1, 5-pin	Pin	Meaning
	<b>OVEM without vacuum sensor</b>	
	1	Supply voltage +24 V DC
	2	Switching input for vacuum ON/OFF
	3	0 V
	4	No function
	5	Switching input for ejector pulse ON/OFF
	<b>OVEM-...-1P/1N</b>	
	1	Supply voltage +24 V DC
	2	Switching input for vacuum ON/OFF
	3	0 V
	4	Switching output (switching output for vacuum sensor)
	5	Switching input for ejector pulse ON/OFF
	<b>OVEM-...-1PD</b>	
	1	Supply voltage +24 V DC
	2	Digital output Out A (switching output for vacuum sensor)
	3	0 V
	4	Digital switching input (ejector pulse)
	5	Digital switching input (vacuum ON/OFF)
	<b>OVEM-...-2P/2N/PU/PI</b>	
	1	Supply voltage +24 V DC
	2	Digital output Out B (OVEM-...-2P/2N)
		Analogue output Out B (OVEM-...-PU/PI)
	3	0 V
	4	Digital output Out A (switching output for vacuum sensor)
	5	Digital switching input (vacuum ON/OFF and ejector pulse)
	<b>OVEM-...-LK</b>	
	1	Supply voltage +24 V DC
	2	Digital output Out B
3	0 V	
4	IO-Link communication or digital output Out A (switching output for vacuum sensor) <sup>1)</sup>	
5	Not allocated, or digital switching input (vacuum ON/OFF and ejector pulse) <sup>2)</sup>	

1) After a fallback or in SIO mode, this pin has the configuration of a digital switching output.  
 2) This pin is not allocated in IO-Link mode. After a fallback or in SIO mode, this pin has the configuration of a digital input.

## Data sheet

Technical data – Vacuum sensor								
Vacuum sensor	[1PD]	[2P]	[2N]	[PU]	[PI]	[LK]	[1P]	[1N]
<b>Input signal/measuring element</b>								
Measured variable	Relative pressure							
Measuring principle	Piezoresistive							
Pressure measuring range	[bar]	–1 ... 0						
<b>Display/operation</b>								
Setting options	Via display and keys						–	
	–					IO-Link	–	
	–						Teach-in	
Threshold value setting range	[bar]	–0.999 ... 0						–1 ... 0
Hysteresis setting range	[bar]	–0.9 ... 0						–
Setting range ejector pulse duration	[ms]	– <sup>1)</sup>	20 ... 9999 (OVEM-05)			40 ... 9999		–
			40 ... 9999 (OVEM-07/10/14/20/30)					
Display type	4-character alphanumeric, backlit LCD						LED	
Displayable units	bar							
	[H]	inchHg					–	
Display range	[bar]	–0.999 ... 0						–
	[inchHg]	–29.5 ... 0					–	
Protection against tampering	PIN code	–				Electronic lock	–	
<b>Accuracy</b>								
Accuracy FS <sup>2)</sup>	[%]	±3						±0.5
Reproducibility of switching value FS <sup>2)</sup>	[%]	0.6						0.6
<b>Inputs/outputs</b>								
Input switching logic	PNP	PNP	NPN	PNP	PNP	PNP	PNP	NPN
Switching output	1x PNP	2x PNP	2x NPN	1x PNP	1x PNP	2x PNP	1x PNP	1x NPN
Switching function	Window comparator						–	
	Threshold value comparator <sup>3)</sup>							
Switching status indication	Optical							
Switching element function	N/O contact							
	N/C contact						–	
Fixed hysteresis	[mbar]	–						20
Max. output current	[mA]	100						
No-load supply current	[mA]	< 70						< 80
Residual current	[mA]	0.1						
Voltage drop	[V]	≤ 2	≤ 1.5			≤ 1.8		≤ 1.5
					0 ... 10	–	–	–
Analogue output	[V]	–			0 ... 10	–	–	–
	[mA]	–			–	4 ... 20	–	–
Permitted load resistance, analogue output	[ohm]	–			Min. 2000	Max. 500	–	–
Accuracy of analogue output FS <sup>2)</sup>	[%]	–			4	–	–	–
Short circuit current rating	Yes							
Inductive protective circuit	Adapted to MZ, MY, ME coils					–		Adapted to MZ, MY, ME coils
Overload protection	Provided							

1) Generation of an ejector pulse via a control signal at the digital switching input.

2) % FS = % of the measuring range final value (full scale)

3) OVEM-...1P/1N threshold value with fixed hysteresis

## Data sheet

Technical data – IO-Link		
Protocol version		Device V 1.1
Profile		Smart sensor profile
Function classes		Binary data channel (BDC)
		Diagnostics
		Identification
		Process data variable (PDV)
		Teach channel
Communication mode		COM2 (38.4 kBd)
Port class		A
Process data width OUT		1 bytes
Process data content OUT		1-bit (ejector pulse ON/OFF)
		1 bit (vacuum ON/OFF)
Process data width IN		2 bytes
Process data content IN		14 bit PDV (pressure measurement value)
		2 bit BDC (pressure monitoring)
Minimum cycle time	[ms]	3.5
Data memory required		0.5 KB
Device ID	OVEM-...-H-...-OE-N-LK	0x00003C
	OVEM-...-L-...-OE-N-LK	0x00003D
	OVEM-...-H-...-OPE-N-LK	0x000104
	OVEM-...-L-...-OPE-N-LK	0x000105
	OVEM-...-H-...-CE-N-LK	0x00003E
	OVEM-...-L-...-CE-N-LK	0x00003F
	OVEM-...-H-...-CPE-N-LK	0x000106
	OVEM-...-L-...-CPE-N-LK	0x000107

## Data sheet

## Materials

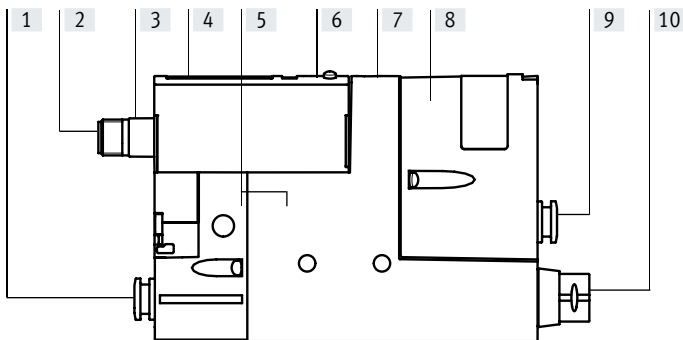

Type		OVEM-...-1PD/2P/2N/PU/PI/LK	OVEM-...-1P/1N
[1]	Fitting	[QS]/[QO]	Nickel-plated brass
	Connecting thread	[GN]/[GO]	Anodised wrought aluminium alloy
[2]	Pin contacts		Gold-plated brass
[3]	Plug housing		Nickel-plated brass
[4]	Inspection window		PA
[5]	Housing		Die-cast aluminium (OVEM-...-B), wrought aluminium alloy (OVEM-...-C), reinforced PA
[6]	Keypad		TPE-U
[7]	Adjusting screw	[OE]/[OPE]/[CE]/[CPE]	Steel
[8]	Filter housing		Reinforced PA
[9]	Fitting	[QS]/[QO]/[PL]/[PO]	Nickel-plated brass
	Connecting thread	[GN]/[GO]	Anodised wrought aluminium alloy
[10]	Silencer	[QO]/[GO]/[PO]	Wrought aluminium alloy, PU foam, POM (OVEM-...-C)
	Fitting	[QS]/[QO]/[PL]/[PO]	Nickel-plated brass
		[GN]/[GO]	Anodised wrought aluminium alloy
-	Screws, pins		Steel
-	Jet nozzle		Wrought aluminium alloy
-	Receiver		POM
-	Filter		Fabric, PA, sintered steel
-	Seals		NBR, HNBR (OVEM-...-C)
-	Hollow bolt	[PL]/[PO]	Wrought aluminium alloy
-	Mounting bracket	[PL]/[PO]	Stainless steel
Note on materials			RoHS-compliant
		[QO]/[GO]/[PO]	Contains paint-wetting impairment substances

Data sheet

Vacuum  $p_u$  as a function of operating pressure  $p_1$

High vacuum

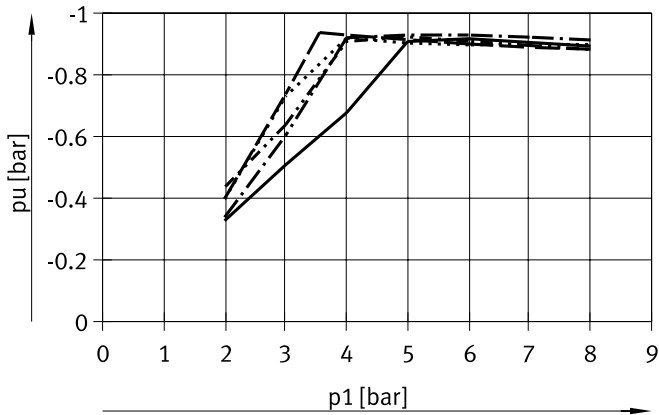

- OVEM-05-H-B
- ..... OVEM-07-H-B
- - - OVEM-10-H-B
- · - · OVEM-14-H-B
- - - - OVEM-20-H-B

High suction rate

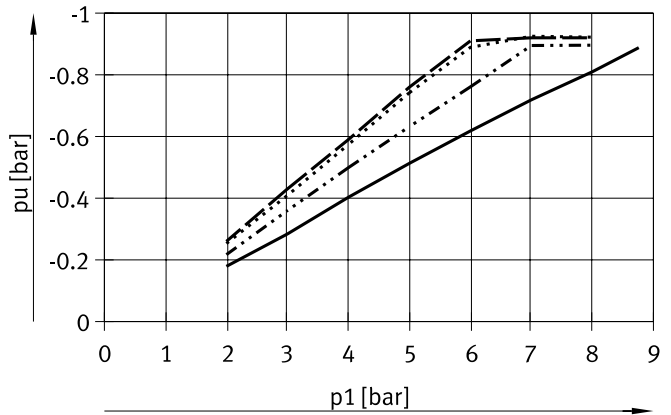

- OVEM-05-L-B
- ..... OVEM-07-L-B
- - - OVEM-10-L-B
- · - · OVEM-14-L-B
- - - - OVEM-20-L-B

Evacuation time  $t$  as a function of vacuum  $p_u$  for 1 l volume at 6 bar operating pressure

High vacuum

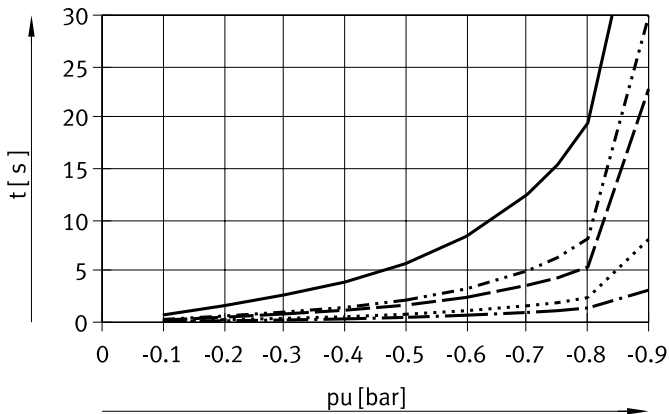

- OVEM-05-H-B
- ..... OVEM-07-H-B
- - - OVEM-10-H-B
- · - · OVEM-14-H-B
- - - - OVEM-20-H-B

High suction rate

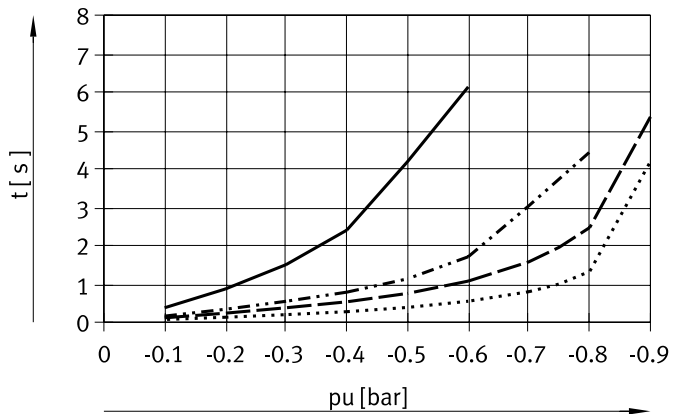

- OVEM-05-L-B
- ..... OVEM-07-L-B
- - - OVEM-10-L-B
- · - · OVEM-14-L-B
- - - - OVEM-20-L-B

Air consumption  $q_n$  as a function of operating pressure  $p_1$

High vacuum/high suction rate

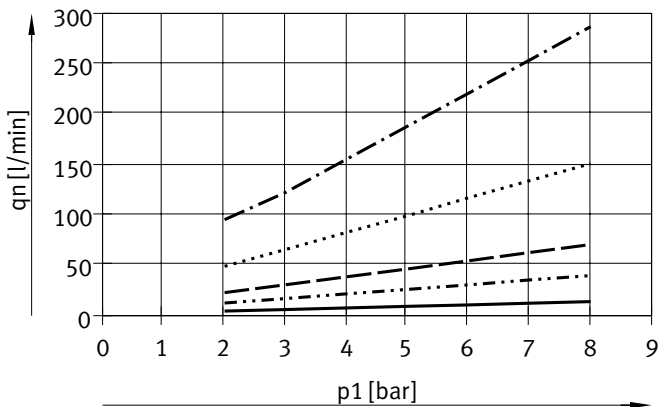

- OVEM-05-H/L-B
- ..... OVEM-07-H/L-B
- - - OVEM-10-H/L-B
- · - · OVEM-14-H/L-B
- - - - OVEM-20-H-B

Data sheet

Vacuum  $p_u$  as a function of operating pressure  $p_1$

High vacuum

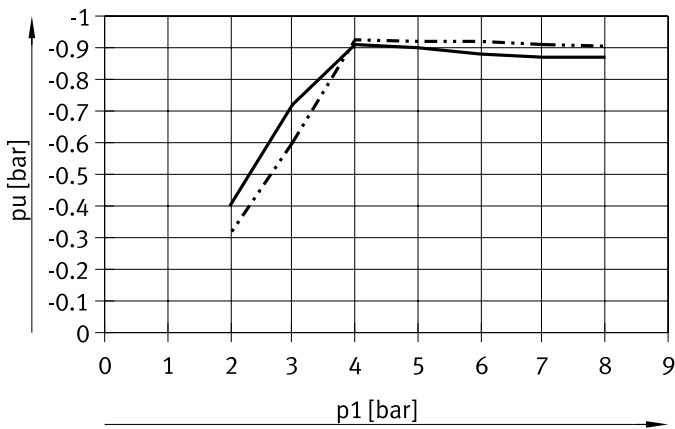

— OVEM-20-H-C  
- · - · OVEM-30-H-C

High suction rate

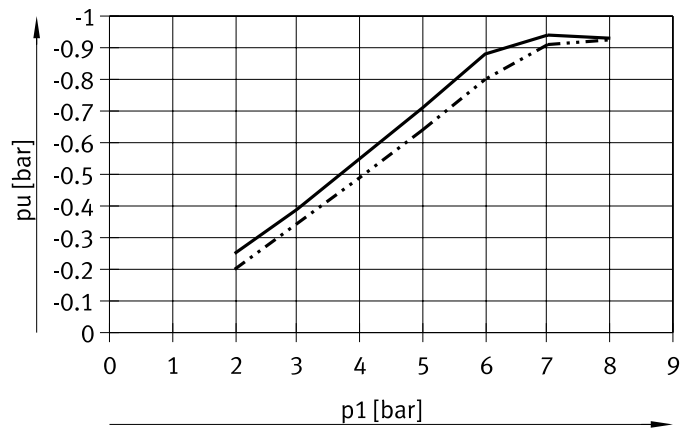

— OVEM-20-L-C  
- · - · OVEM-30-L-C

Evacuation time  $t$  as a function of vacuum  $p_u$  for 1 l volume at 6 bar operating pressure

High vacuum

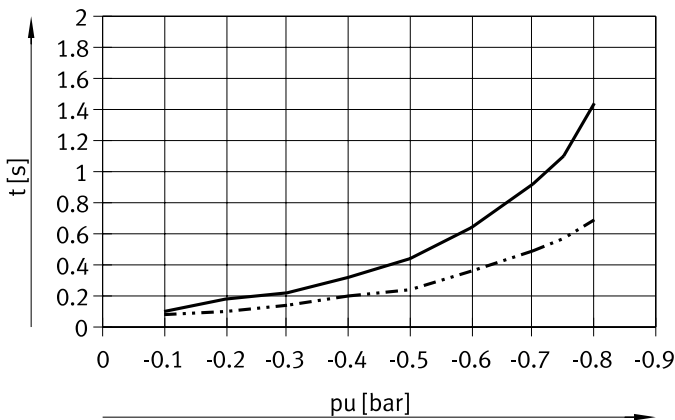

— OVEM-20-H-C  
- · - · OVEM-30-H-C

High suction rate

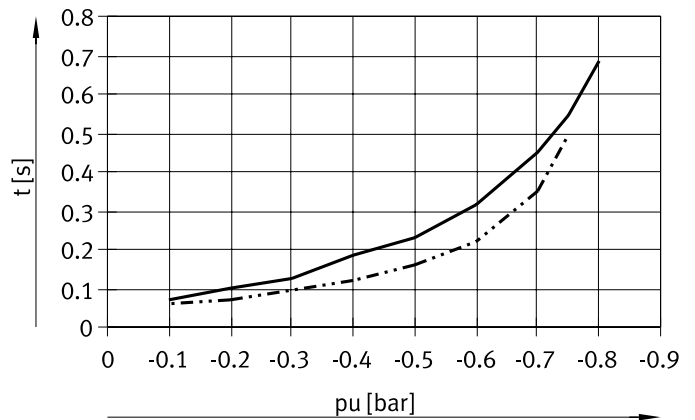

— OVEM-20-L-C  
- · - · OVEM-30-L-C

Air consumption  $q_n$  as a function of operating pressure  $p_1$

High vacuum/high suction rate

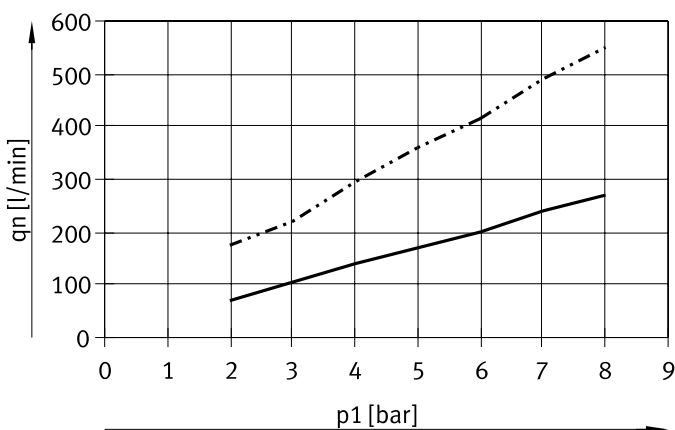

— OVEM-20-H/L-C  
- · - · OVEM-30-H/L-C

Data sheet

Dimensions

Download CAD data → [www.festo.com](http://www.festo.com)

OVEM-05-...-B

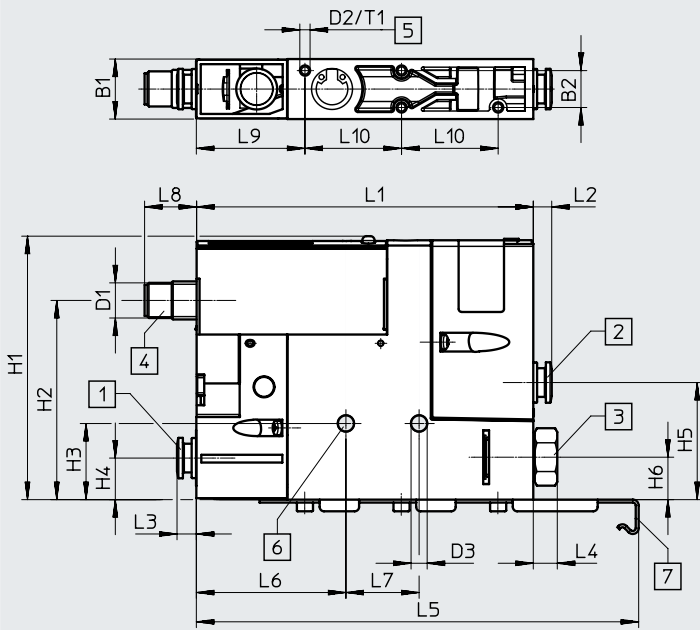

- [1] Supply port (P)
- [2] Vacuum port (V)
- [3] Exhaust port (R)
- [4] Electrical connection to fit NEBU-M12G5-K
- [5] Mounting thread M3  
Max. tightening torque 0.8 Nm
- [6] Mounting hole  
Max. tightening torque 2.5 Nm
- [7] Mounting bracket only with OVEM-...-B-PL/PO

Type	Pneumatic connections			B1	B2	D1	D2	D3	H1	H2	H3	H4	H5	H6
	P	V	R											
OVEM-05-...-B-QS	QS-6	QS-6	QS-8	20.5	12.6	M12x1	M3	5.5	90	68	26	14.5	40	14.5
OVEM-05-...-B-QO			SD <sup>2)</sup>											
OVEM-05-...-B-PL	(G1/4) <sup>1)</sup>	QS-6	QS-8											
OVEM-05-...-B-PO			SD <sup>2)</sup>											
OVEM-05-...-B-GN	G1/8	G1/8	G1/8											
OVEM-05-...-B-GO			SD <sup>2)</sup>											

Type	L1	L2	L3	L4	L5	L6	L7	L8	L9	L10	T1
OVEM-05-...-B-QS	115	6.5	6.5	12	-	51	25	18	37	33	5.5
OVEM-05-...-B-QO				-							
OVEM-05-...-B-PL				12							
OVEM-05-...-B-PO		-									
OVEM-05-...-B-GN		8.2	8.2	8.2							
OVEM-05-...-B-GO				-							

1) Thread for mounting on the common supply manifold → page 23  
 2) SD = Silencer

Minimum inside diameter [mm] of the connection tubes for connections with G female thread

Type	OVEM-05-...-B-GN/GO	
Tube length	< 0.5 m	< 2 m
Pneumatic port 1 (P)	1	2
Vacuum port (V)	2	3
Pneumatic port 3 (R)	2	3



Data sheet

Dimensions

Download CAD data → [www.festo.com](http://www.festo.com)

OVEM-07/10-...-B

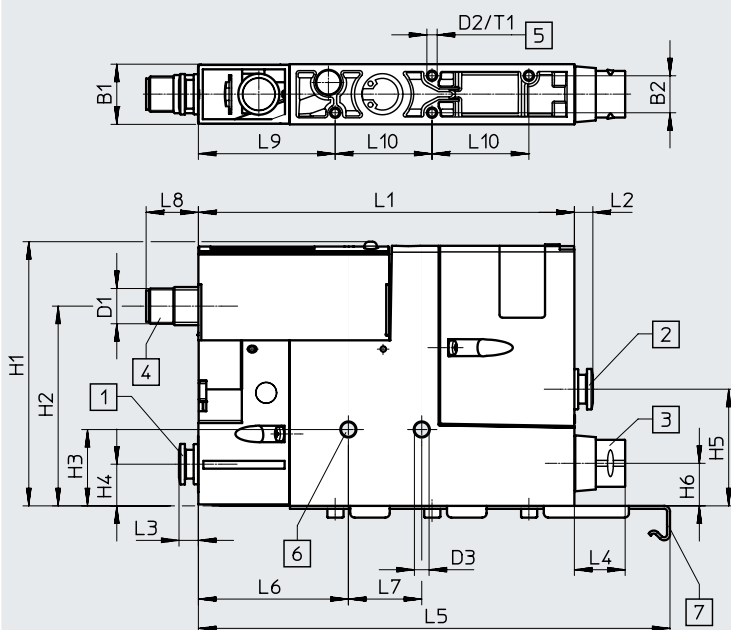

- [1] Supply port (P)
- [2] Vacuum port (V)
- [3] Exhaust port (R)
- [4] Electrical connection to fit NEBU-M12G5-K
- [5] Mounting thread M3  
Max. tightening torque 0.8 Nm
- [6] Mounting hole  
Max. tightening torque 2.5 Nm
- [7] Mounting bracket only with OVEM-...-B-PL/PO

Type	Pneumatic connections			B1	B2	D1	D2	D3	H1	H2	H3	H4	H5	H6
	P	V	R											
OVEM-07/10-...-B-QS	QS-8	QS-8	QS-8	20.5	12.6	M12x1	M3	5.5	90	68	26	14.5	40	14.5
OVEM-07/10-...-B-QO			SD <sup>2)</sup>											
OVEM-07/10-...-B-PL	(G1/4) <sup>1)</sup>	QS-8	QS-8											
OVEM-07/10-...-B-PO			SD <sup>2)</sup>											
OVEM-07/10-...-B-GN	G1/4	G1/4	G3/8											
OVEM-07/10-...-B-GO			SD <sup>2)</sup>											

Type	L1	L2	L3	L4	L5	L6	L7	L8	L9	L10	T1
OVEM-07/10-...-B-QS	128	6.5	6.5	12	-	51	25	18	46.5	33	5.5
OVEM-07/10-...-B-QO				17.3							
OVEM-07/10-...-B-PL				12							
OVEM-07/10-...-B-PO		17.3	160.5								
OVEM-07/10-...-B-GN		17.2	17.2	-	-						
OVEM-07/10-...-B-GO				17.3							

1) Thread for mounting on the common supply manifold → page 23  
 2) SD = Silencer

Minimum inside diameter [mm] of the connection tubes for connections with G female thread

Type	OVEM-07-...-B-GN/GO		OVEM-10-...-B-GN/GO	
	< 0.5 m	< 2 m	< 0.5 m	< 2 m
Pneumatic port 1 (P)	1.5	2	2	3
Vacuum port (V)	3	4	4	5
Pneumatic port 3 (R)	3	4	4	5

Data sheet

Dimensions

OVEM-14/20-...-B

Download CAD data → [www.festo.com](http://www.festo.com)

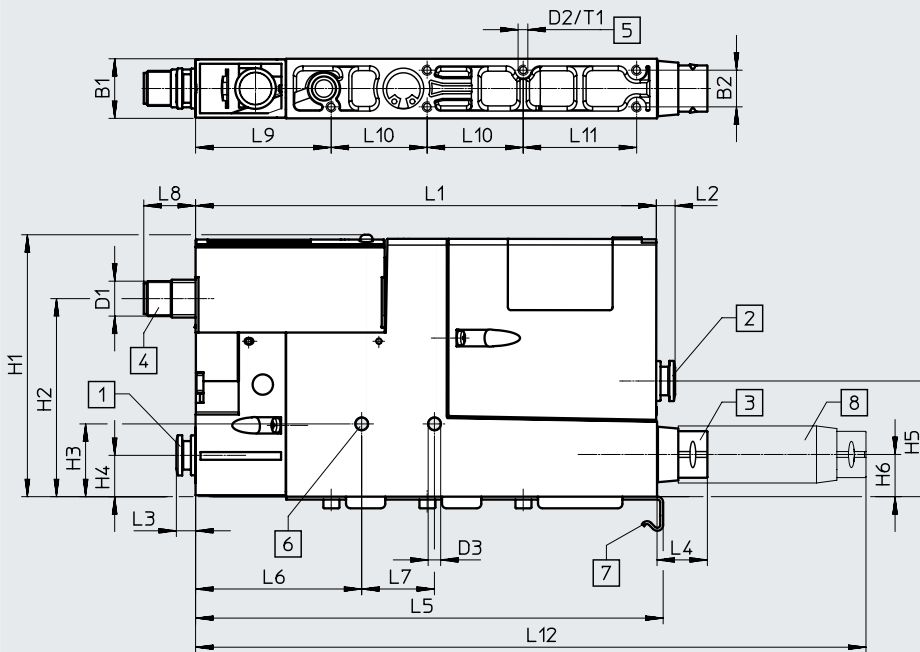

- [1] Supply port (P)
- [2] Vacuum port (V)
- [3] Exhaust port (R)
- [4] Electrical connection to fit NEBU-M12G5-K
- [5] Mounting thread M3  
Max. tightening torque 0.8 Nm
- [6] Mounting hole  
Max. tightening torque 2.5 Nm
- [7] Mounting bracket only with OVEM-...-B-PL/PO
- [8] Silencer extension (included in the scope of delivery for OVEM-20)

Type	Pneumatic connections			B1	B2	D1	D2	D3	H1	H2	H3	H4	H5	H6
	P	V	R											
OVEM-14/20-...-B-QS	QS-8	QS-8	QS-8	20.5	12.6	M12x1	M3	4.3	90	68	25	14.5	40	14.5
OVEM-14/20-...-B-QO			SD <sup>2)</sup>											
OVEM-14/20-...-B-PL	(G1/4) <sup>1)</sup>	QS-8	QS-8											
OVEM-14/20-...-B-PO			SD <sup>2)</sup>											
OVEM-14/20-...-B-GN	G1/4	G1/4	G3/8											
OVEM-14/20-...-B-GO			SD <sup>2)</sup>											

Type	L1	L2	L3	L4	L5	L6	L7	L8	L9	L10	L11	L12	T1
OVEM-14/20-...-B-QS	158	6.5	6.5	12	-	57	25	18	46.5	33	39	-	5.5
OVEM-14/20-...-B-QO				17.3									
OVEM-14/20-...-B-PL			-	12									
OVEM-14/20-...-B-PO		17.3											
OVEM-14/20-...-B-GN		17.2	17.2	-	-								
OVEM-14/20-...-B-GO				17.3									

1) Thread for mounting on the common supply manifold → page 23  
 2) SD = Silencer

Minimum inside diameter [mm] of the connection tubes for connections with G female thread

Type	OVEM-14-...-B-GN/GO		OVEM-20-...-B-GN/GO	
	< 0.5 m	< 2 m	< 0.5 m	< 2 m
Pneumatic port 1 (P)	3	4	4	5
Vacuum port (V)	5.5	6	6	7
Pneumatic port 3 (R)	5.5	6	6	7

Data sheet

Dimensions

Download CAD data → [www.festo.com](http://www.festo.com)

OVEM-20/30-...-C

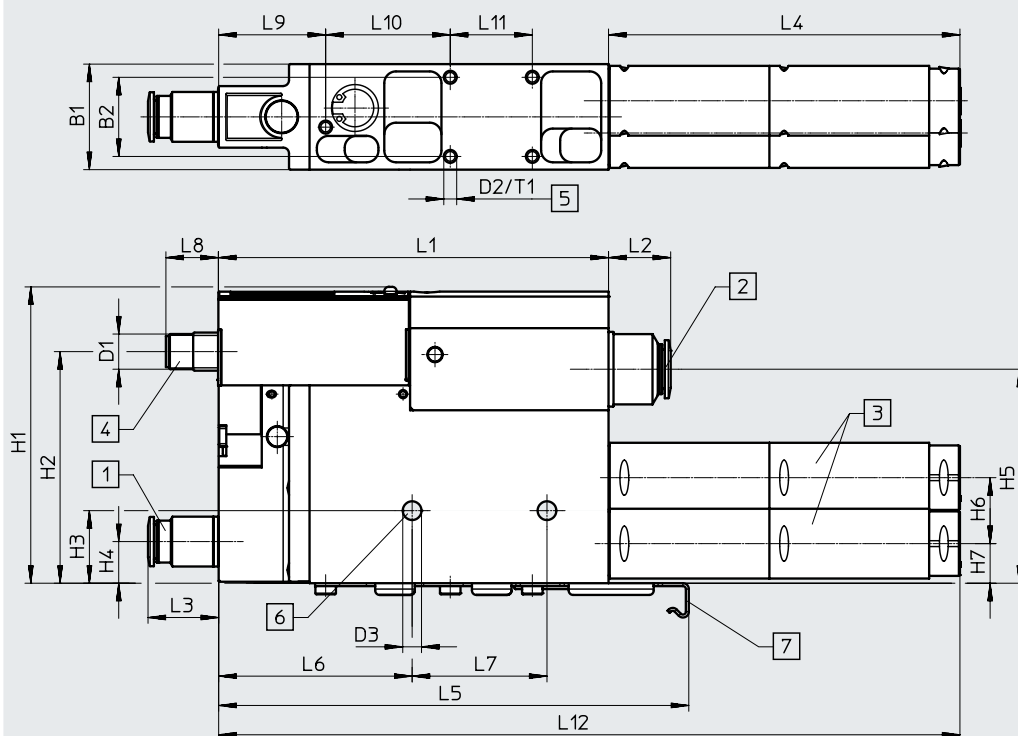

- [1] Supply port (P)
- [2] Vacuum port (V)
- [3] Exhaust port (R)
- [4] Electrical connection to fit NEBU-M12G5-K
- [5] Mounting thread M4  
Max. tightening torque 0.8 Nm
- [6] Mounting hole  
Max. tightening torque 2.5 Nm
- [7] Mounting bracket only with OVEM-...-C-PL/PO

Type	Pneumatic connections			B1	B2	D1	D2	D3 ∅	H1	H2	H3	H4	H5	H6	H7
	P	V	R												
OVEM-20/30-...-C-QS	QS-10	QS-12 (QS-16) <sup>2)</sup>	QS-12 (QS-16) <sup>2)</sup>	36	27	M12x1	M4	6.4	101	79	25	~14.5	73	22.5	13
OVEM-20/30-...-C-QO			SD <sup>3)</sup>												
OVEM-20/30-...-C-PL	(G1/4) <sup>1)</sup>	QS-12 (QS-16) <sup>2)</sup>	QS-12 (QS-16) <sup>2)</sup>												
OVEM-20/30-...-C-PO			SD <sup>3)</sup>												
OVEM-20/30-...-C-GN	G1/4	G1/2	G3/8												
OVEM-20/30-...-C-GO			SD <sup>3)</sup>												

Type	L1	L2	L3	L4	L5	L6	L7	L8	L9	L10	L11	L12	T1
OVEM-20/30-...-C-QS	133	21.2 (28.7) <sup>2)</sup>	24	25.7 (31.7) <sup>2)</sup>	-	66	46	~18	36.5	42.5	28	~253	8.5
OVEM-20/30-...-C-QO				120									
OVEM-20/30-...-C-PL				25.7 (31.7) <sup>2)</sup>									
OVEM-20/30-...-C-PO				120									
OVEM-20/30-...-C-GN				-									
OVEM-20/30-...-C-GO	-	120											

1) Thread for mounting on the common supply manifold → page 23  
 2) Value in brackets applies to OVEM-30-L  
 3) SD = Silencer

Minimum inside diameter [mm] of the connection tubes for connections with G female thread				
Type	OVEM-20-...-C-GN/GO		OVEM-30-...-C-GN/GO	
Tube length	< 0.5 m	< 2 m	< 0.5 m	< 2 m
Pneumatic port 1 (P)	4	5	6	7
Vacuum port (V)	6	7	7	11
Pneumatic port 3 (R)	6	7	9	11

Data sheet

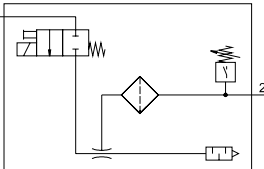
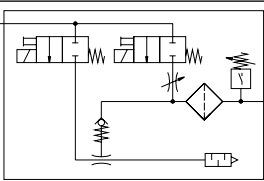
Ordering data and weights – OVEM-...-B								
Circuit symbol	Description	Electrical switching output	Display	Nominal width of Laval nozzle [mm]	Weight [g]	Part no.	Type	
<b>NC – normally closed</b>								
	P-V with QS fitting, R with open silencer	2x PNP	LCD	0.45	320	538834	OVEM-05-H-B-QO-CN-N-2P	
				0.7	325	538835	OVEM-07-H-B-QO-CN-N-2P	
				0.95		538836	OVEM-10-H-B-QO-CN-N-2P	
				1.4	370	539998	OVEM-14-H-B-QO-CN-N-2P	
	With ejector pulse, P-V with QS fitting, R with open silencer	2x PNP	LCD	0.45	325	538831	OVEM-05-H-B-QO-CE-N-2P	
				0.7	330	538832	OVEM-07-H-B-QO-CE-N-2P	
				0.95		538833	OVEM-10-H-B-QO-CE-N-2P	
				1.4	380	539997	OVEM-14-H-B-QO-CE-N-2P	
		2x NPN	LCD	0.7	330	540018	OVEM-07-H-B-QO-CE-N-2N	
				0.95		540019	OVEM-10-H-B-QO-CE-N-2N	
				1.4	380	540020	OVEM-14-H-B-QO-CE-N-2N	
				2.0		8023700	OVEM-20-H-B-QO-CE-N-2P	
		PNP	LED	0.45	315	540021	OVEM-05-H-B-QO-CE-N-1P	
				0.7	320	540022	OVEM-07-H-B-QO-CE-N-1P	
				0.95		540023	OVEM-10-H-B-QO-CE-N-1P	
				1.4	371	540024	OVEM-14-H-B-QO-CE-N-1P	
			LCD	0.45	325	8037697	OVEM-05-H-B-QO-CE-N-1PD	
				0.7	330	8037698	OVEM-07-H-B-QO-CE-N-1PD	
				0.95		8037699	OVEM-10-H-B-QO-CE-N-1PD	
				1.4	380	8037700	OVEM-14-H-B-QO-CE-N-1PD	
		IO-Link, 2x PNP in SIO mode	LCD	0.45	325	8037693	OVEM-05-H-B-QO-CE-N-LK	
				0.7	330	8037694	OVEM-07-H-B-QO-CE-N-LK	
				0.95		8037695	OVEM-10-H-B-QO-CE-N-LK	
				1.4	380	8037696	OVEM-14-H-B-QO-CE-N-LK	
		With ejector pulse, P-V with female thread, R with open silencer	2x PNP	LCD	0.7	335	540015	OVEM-07-H-B-GO-CE-N-2P
					0.95		540016	OVEM-10-H-B-GO-CE-N-2P
					1.4		540017	OVEM-14-H-B-GO-CE-N-2P
			2x NPN	LCD	0.7	335	540012	OVEM-07-H-B-GO-CE-N-2N
0.95					540013	OVEM-10-H-B-GO-CE-N-2N		
1.4	385				540014	OVEM-14-H-B-GO-CE-N-2N		
PNP	LED		0.45	300	540025	OVEM-05-H-B-GO-CE-N-1P		
			0.7	325	540026	OVEM-07-H-B-GO-CE-N-1P		
		0.95		540027	OVEM-10-H-B-GO-CE-N-1P			
With ejector pulse, prepared for common supply manifold, V with QS fitting, R with open silencer	2x PNP	LCD	2.0	410	8023702	OVEM-20-H-B-PO-CE-N-2P		
	PNP	LED	2.0	400	8023701	OVEM-20-H-B-PO-CE-N-1P		

Data sheet

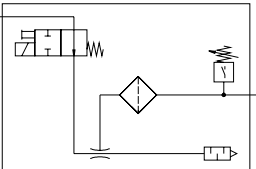
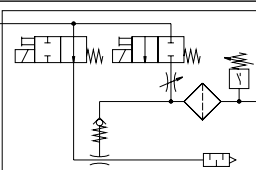
Ordering data and weights – OVEM-...-B							
Circuit symbol	Description	Electrical switching output	Display	Nominal width of Laval nozzle [mm]	Weight [g]	Part no.	Type
<b>NO – normally open</b>							
	P-V with QS fitting, R with open silencer	2x PNP	LCD	0.45	320	538828	OVEM-05-H-B-QO-ON-N-2P
				0.7	325	538829	OVEM-07-H-B-QO-ON-N-2P
				0.95		538830	OVEM-10-H-B-QO-ON-N-2P
				1.4	370	539996	OVEM-14-H-B-QO-ON-N-2P
	With ejector pulse, P-V with QS fitting, R with open silencer	2x PNP	LCD	0.45	325	538825	OVEM-05-H-B-QO-OE-N-2P
				0.7	330	538826	OVEM-07-H-B-QO-OE-N-2P
				0.95		538827	OVEM-10-H-B-QO-OE-N-2P
				1.4	380	539995	OVEM-14-H-B-QO-OE-N-2P
	With ejector pulse, P-V with female thread, R with open silencer	2x PNP	LCD	0.7	335	540006	OVEM-07-H-B-GO-OE-N-2P
				0.95		540007	OVEM-10-H-B-GO-OE-N-2P
		2x NPN	LCD	1.4	385	540008	OVEM-14-H-B-GO-OE-N-2P
				0.7	335	540003	OVEM-07-H-B-GO-OE-N-2N
				0.95		540004	OVEM-10-H-B-GO-OE-N-2N
				1.4	385	540005	OVEM-14-H-B-GO-OE-N-2N

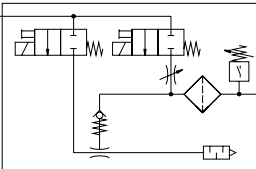
Ordering data and weights – OVEM-...-C							
Circuit symbol	Description	Electrical switching output	Display	Nominal width of Laval nozzle [mm]	Weight [g]	Part no.	Type
<b>NC – normally closed</b>							
	With ejector pulse, P-V with QS fitting, R with open silencer	2x PNP	LCD	2.0	825	8070092	OVEM-20-H-C-QO-CE-N-2P
				3.0		8070094	OVEM-30-H-C-QO-CE-N-2P
		PNP	LED	2.0	815	8070091	OVEM-20-H-C-QO-CE-N-1P
				3.0		8070093	OVEM-30-H-C-QO-CE-N-1P
			LCD	2.0	825	8070095	OVEM-20-H-C-QO-CE-N-1PD
				3.0		8070097	OVEM-30-H-C-QO-CE-N-1PD
		IO-Link, 2x PNP in SIO mode	LCD	2.0	825	8070096	OVEM-20-H-C-QO-CE-N-LK
				3.0		8070098	OVEM-30-H-C-QO-CE-N-LK

Ordering data – Modular product system

Ordering table		Conditions	Code	Enter code
Type	OVEM			
Module no.	<b>539074</b>			
Vacuum generator	Vacuum generator with solenoid valve for vacuum on/off and manual override		<b>OVEM</b>	OVEM
Nominal width of Laval nozzle [mm]	0.45		<b>-05</b>	
	0.7		<b>-07</b>	
	0.95		<b>-10</b>	
	1.4		<b>-14</b>	
	2.0		<b>-20</b>	
	3.0		<b>-30</b>	
Ejector characteristic	High vacuum		<b>-H</b>	
	High suction rate	[1]	<b>-L</b>	
Housing size/width [mm]	20	[2]	<b>-B</b>	
	36	[3]	<b>-C</b>	
Pneumatic connections	All connections with QS fittings		<b>-QS</b>	
	Supply/vacuum port with QS fittings, exhaust port with open silencer		<b>-QO</b>	
	All connections with G female thread		<b>-GN</b>	
	Supply / vacuum port with G female thread, exhaust port with open silencer		<b>-GO</b>	
	Prepared for supply manifold, vacuum port and exhaust port with QS fittings		<b>-PL</b>	
	Prepared for supply manifold, vacuum port with QS fittings, exhaust port with open silencer		<b>-PO</b>	
Normal position of the vacuum generator	NO, normally open (vacuum generation)		<b>-ON</b>	
	NO, normally open (vacuum generation) with ejector pulse		<b>-OE</b>	
	N/O, normally open (vacuum generation) with power ejector pulse	[4]	<b>-OPE</b>	
	NC, normally closed (no vacuum generation)		<b>-CN</b>	
	NC, normally closed (no vacuum generation) with ejector pulse		<b>-CE</b>	
	N/C, normally closed (no vacuum generation) with power ejector pulse	[4]	<b>-CPE</b>	
Electrical connection	M12 plug (5-pin)		<b>-N</b>	-N
Vacuum sensor, (standard scale in bar)	Without vacuum sensor			
	1 switching output PNP		<b>-1P</b>	
	1 switching output PNP and LCD display	[5]	<b>-1PD</b>	
	1 switching output NPN		<b>-1N</b>	
	2 switching outputs PNP		<b>-2P</b>	
	1 switching output PNP, 1 analogue output 0 ... 10 V		<b>-PU</b>	
	1 switching output PNP, 1 analogue output 4 ... 20 mA		<b>-PI</b>	
	2 switching outputs NPN		<b>-2N</b>	
	IO-Link	[5]	<b>-LK</b>	
Alternative vacuum display	None			
	inchHg	[6]	<b>-H</b>	

- [1] L Not with Laval nozzle nominal width 20 in combination with housing size/width B.
- [2] B Not with Laval nozzle nominal width 30.
- [3] C Not with Laval nozzle nominal width 05, 07, 10, 14.
- [4] OPE, CPE Not with housing size/width B.
- [5] 1PD, LK Not with normal position of the vacuum generator ON, CN.
- [6] H Only with vacuum sensor 2P, PU, PI, 2N, LK.

## Accessories

### Common supply manifold OABM-P

For vacuum generator  
OVEM-...-PL/PO

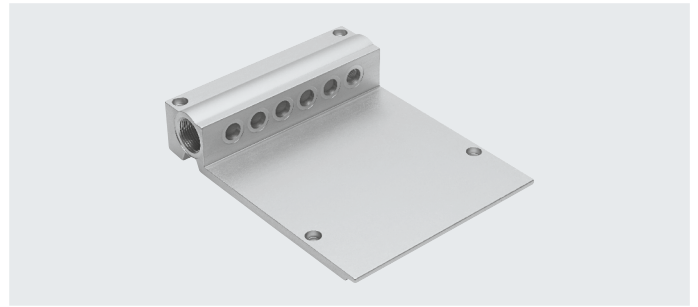

#### General technical data

Pneumatic port 1	G3/4
Type of mounting	With through-hole

#### Materials

Sub-base	Wrought aluminium alloy
Note on materials	RoHS-compliant

#### Dimensions

Download CAD data → [www.festo.com](http://www.festo.com)

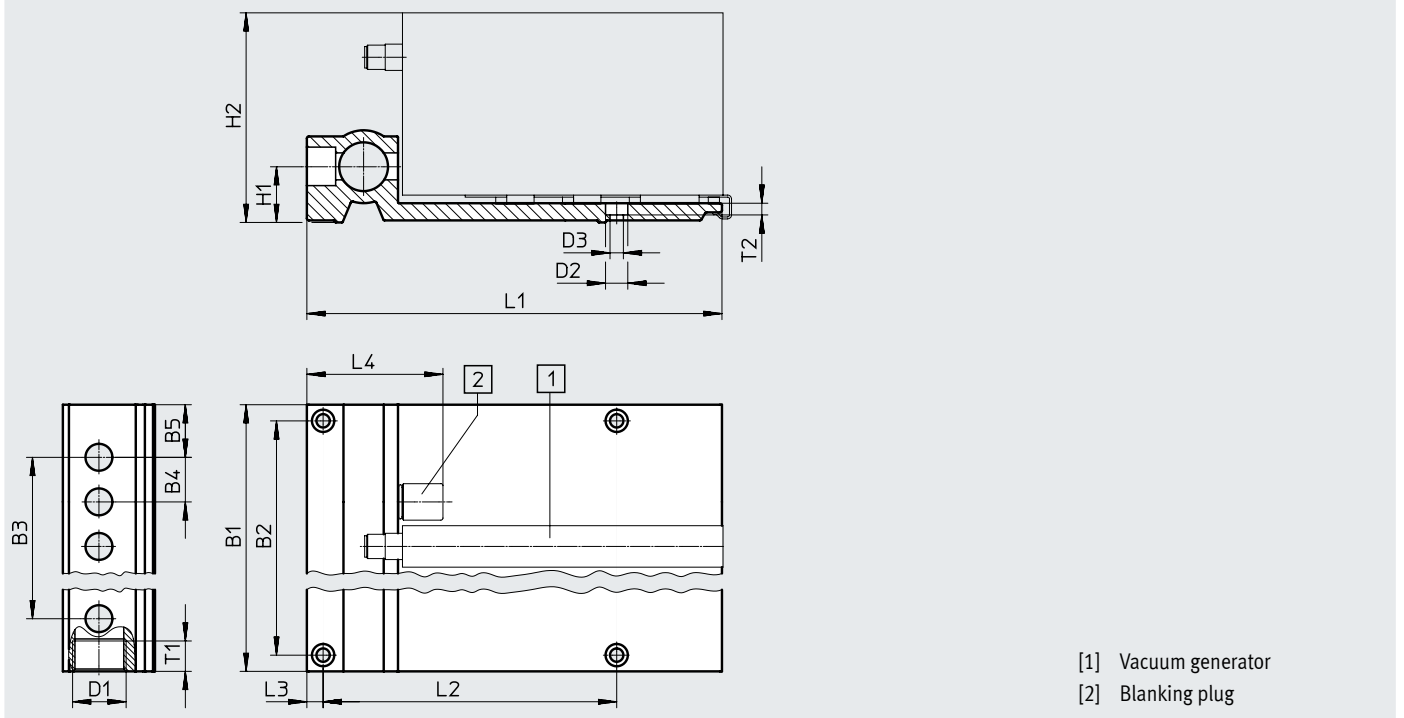

Type	Number of device positions	B1	B2	B3	B4	B5	D1	D2 ∅	D3 ∅	H1	H2	L1	L2	L3	L4	T1	T2
<b>For OVEM-...-B-PL/PO</b>																	
OABM-P-4	4	118	102	66	22	26	G3/4	11	6.6	28	103.5	205	145	8	67	15	5.8
OABM-P-6	6	162	146	110													
OABM-P-8	8	206	190	154													
<b>For OVEM-...-C-PL/PO</b>																	
OABM-P-G1-36-2	2	118	102	38	38	26	G3/4	11	6.6	28	103.5	205	145	8	67	15	5.8
OABM-P-G1-36-4	4	194	178	114													

## Accessories

Tubing inside diameter $d_i$ as a function of total air consumption $q_{rN}$																	
Total air consumption [l/min]																	
50	75	154	175	225	310	400	480	500	750	890	1000	1190	1340	1850	2240	2300	2900
Tubing inside diameter <sup>1)</sup> [mm]																	
≥ 2.5	≥ 2.9	≥ 3.8	≥ 4	≥ 4.4	≥ 5	≥ 5.5	≥ 5.9	≥ 6	≥ 7	≥ 7.5	≥ 8	≥ 8.4	≥ 8.8	≥ 10	≥ 10.8	≥ 11	≥ 12
Recommended tubing																	
PUN-H-4	PUN-H-6	PUN-H-8	PUN-H-10	PUN-H-12	PUN-H-14	PUN-H-16	Data sheets → Internet: pun-h, pan										
PUN-H-4	PUN-H-6	PUN-H-8	PUN-H-10	PUN-H-12	PUN-H-14	PUN-H-16	PAN-16										

1) With a tubing length of 3 m.

 **Note**

The total air consumption of the fully equipped common supply manifold can be determined by adding the individual consumption of each generator used. Note that, in the case of vacuum generators with ejector pulse, the individually set values for the ejector pulse (duration and intensity) can result in much higher air consumption.

Ordering data and weight	Number of device positions	CRC <sup>1)</sup>	Weight [g]	Part no.	Type
For OVEM-...-B-PL/PO	4	2	767	549456	OABM-P-4
	6	2	1045	549457	OABM-P-6
	8	2	1330	549458	OABM-P-8
For OVEM-...-C-PL/PO	2	2	806	8100283	OABM-P-G1-36-2
	4	2	1327	8100284	OABM-P-G1-36-4

1) Corrosion resistance class CRC 2 to Festo standard FN 940070

Moderate corrosion stress. Indoor applications in which condensation can occur. External visible parts with primarily decorative surface requirements which are in direct contact with a normal industrial environment.



## Accessories

### Blanking plug OASC-G1-P

For common supply manifold OABM-P

Max. tightening torque: 10 Nm

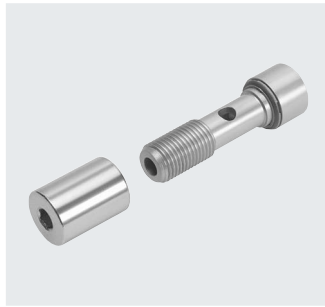

General technical data				
Type of mounting	Screw-in			
Materials				
Hollow bolt	Wrought aluminium alloy			
Cap nut	Steel			
Seals	NBR, steel			
Note on materials	RoHS-compliant			
Ordering data				
	CRC <sup>1)</sup>	Weight [g]	Part no.	Type
For common supply manifold OABM-P	2	53	549460	OASC-G1-P

1) Corrosion resistance class CRC 2 to Festo standard FN 940070

Moderate corrosion stress. Indoor applications in which condensation can occur. External visible parts with primarily decorative surface requirements which are in direct contact with a normal industrial environment.

### H-rail mounting

#### OABM-H

For vacuum generator OVEM-...-B

Max. tightening torque for H-rail mounting: 0.8 Nm

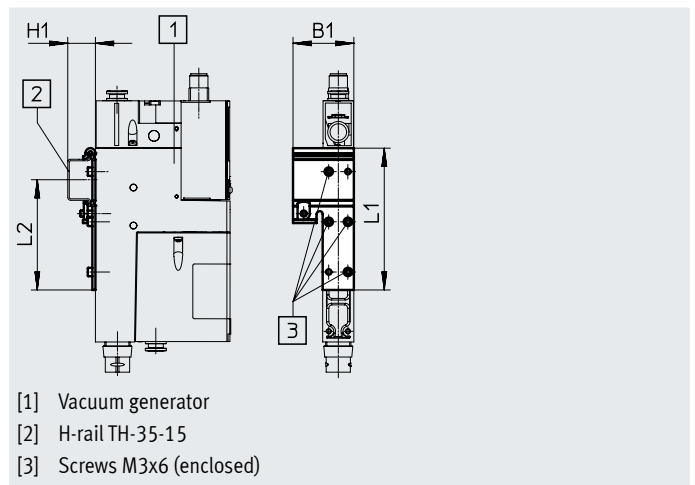

Materials								
H-rail mounting	Galvanised steel							
Note on materials	RoHS-compliant							
Dimensions and ordering data								
	Dimensions [mm]				CRC <sup>1)</sup>	Weight [g]	Part no.	Type
	B1	H1	L1	L2				
For vacuum generator OVEM-...-B	40	18	93	72.5	1	52	549461	OABM-H

1) Corrosion resistance class CRC 1 to Festo standard FN 940070

Low corrosion stress. Dry indoor application or transport and storage protection. Also applies to parts behind covers, in the non-visible interior area, and parts which are covered in the application (e.g. drive trunnions).

Accessories

Ordering data – Connecting cable NEBU-M12

Data sheets → Internet: nebu

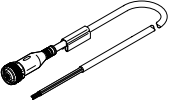
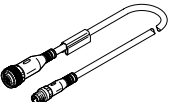
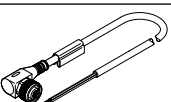
	Electrical connection		Cable length [m]	Part no.	Type
	Straight socket, M12x1, 5-pin	Open end, 5-wire	2.5	541330	NEBU-M12G5-K-2.5-LE5
			5	541331	NEBU-M12G5-K-5-LE5
			10	554038	NEBU-M12G5-K-10-LE5
	Straight socket, M12x1, 5-pin	Straight plug, M8x1, 4-pin, rotatable thread	2.5	554036	NEBU-M12G5-K-2.5-M8G4
	Angled socket, M12x1, 5-pin	Open end, 5-wire	2.5	567843	NEBU-M12W5-K-2.5-LE5
			5	567844	NEBU-M12W5-K-5-LE5

Ordering data – Silencer extension UOMS

Data sheets → Internet: uoms

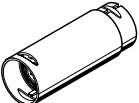
Description	Design	Type of mounting	Part no.	Type
	For OVEM-...-B	Open silencer	538436	UOMS-1/4
	For OVEM-...-C	Open silencer	538437	UOMS-3/8

Ordering data – Mounting bracket HRM

Data sheets → Internet: hrm

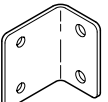
Description	Material	Part no.	Type
	For OVEM-...-B	Galvanised steel	9769
			HRM-1